

# 多媒體製作與應用 作品集

資二 1 06 許寓凱

sketchup 作品 01 : 房子

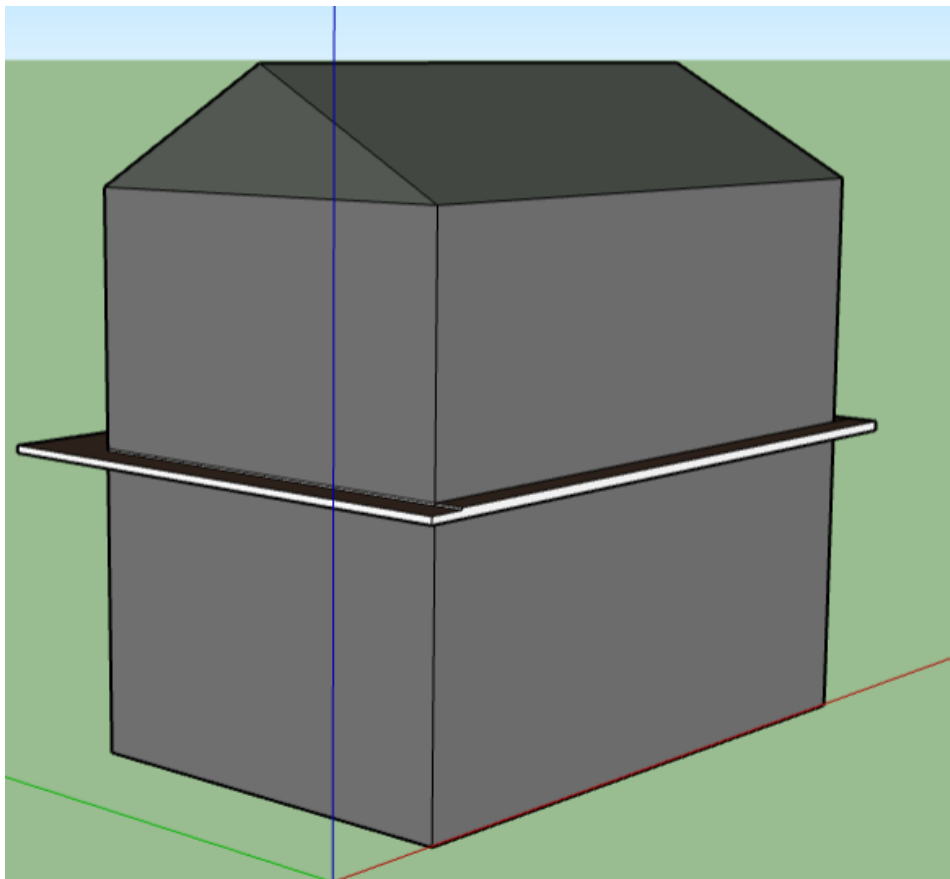

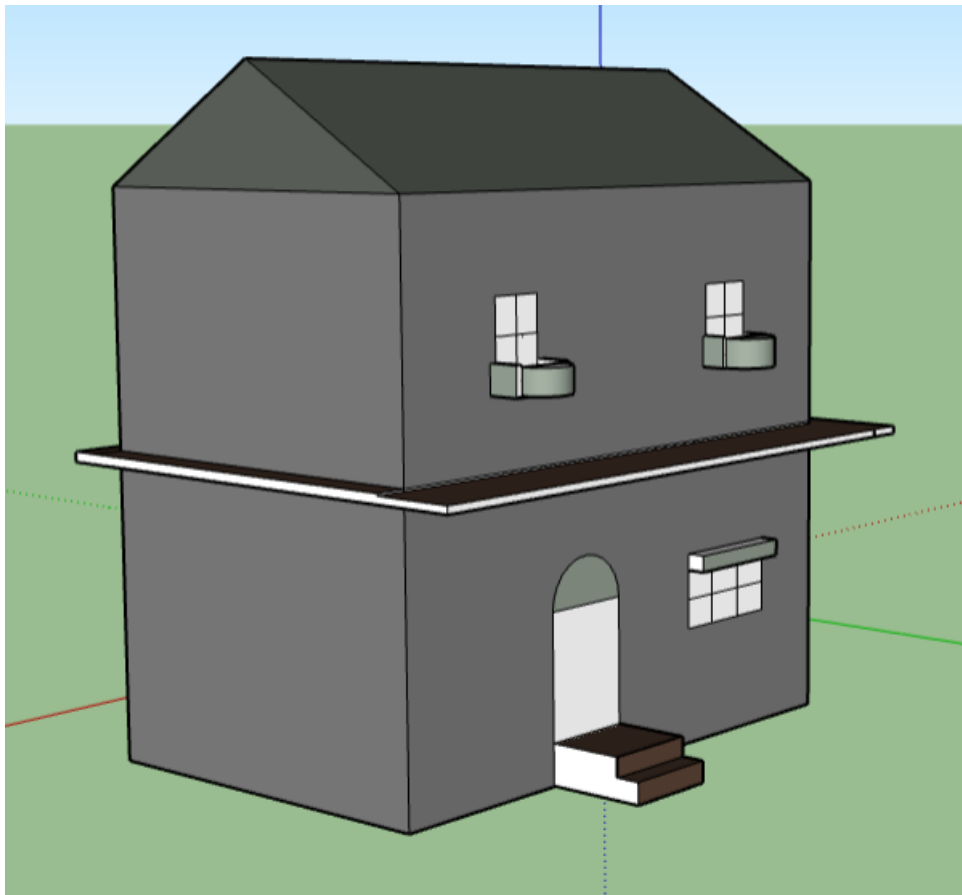
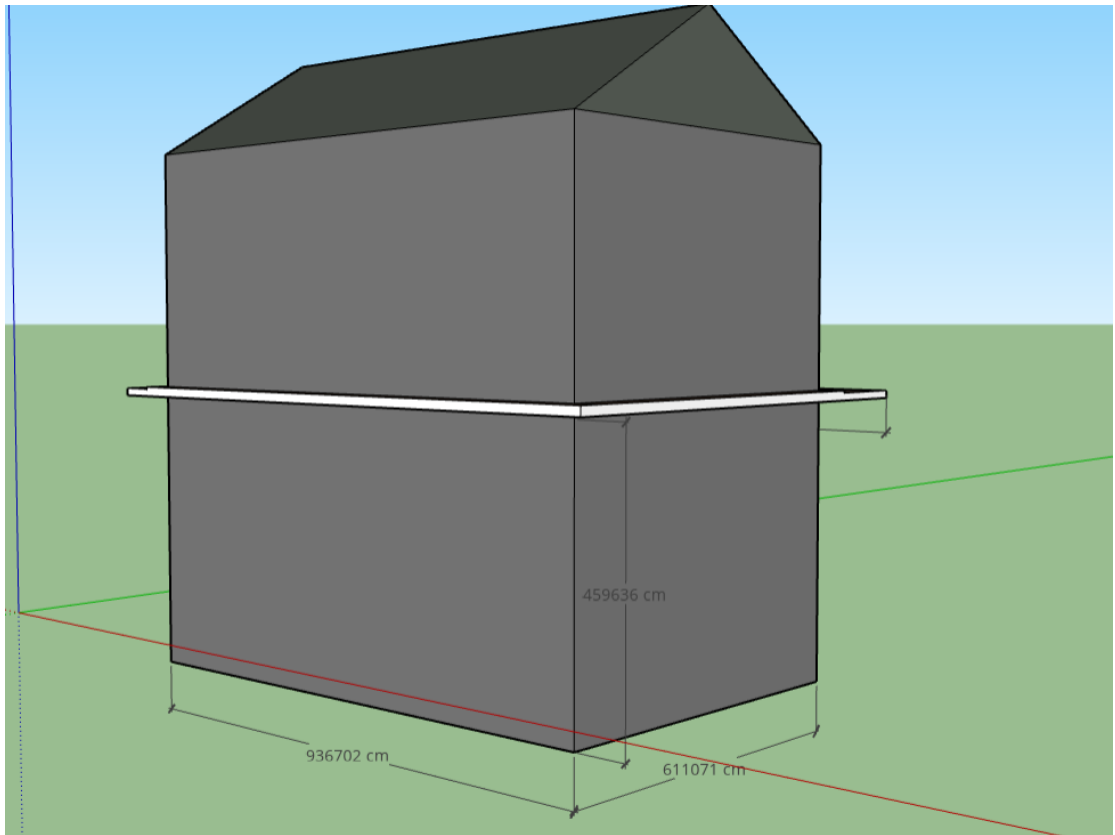
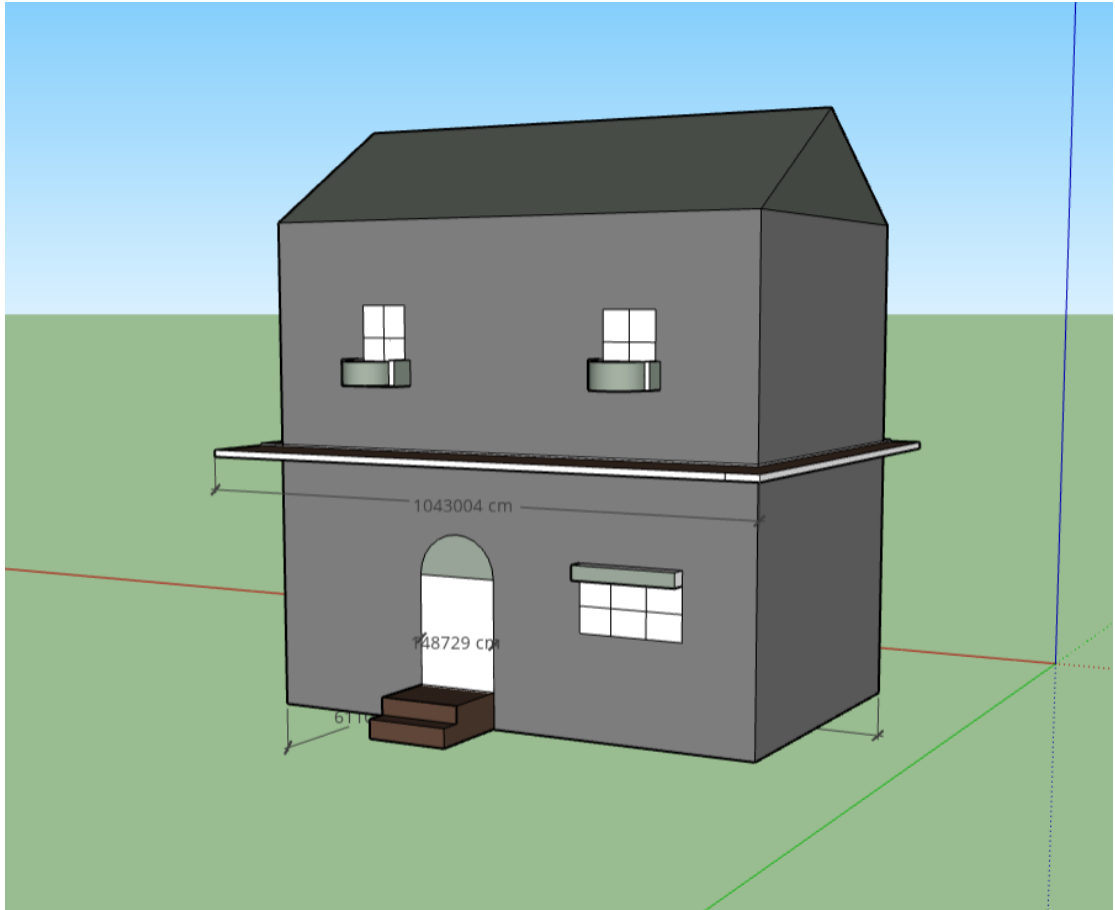

## sketchup 作品 02：茶几、書櫃、相框

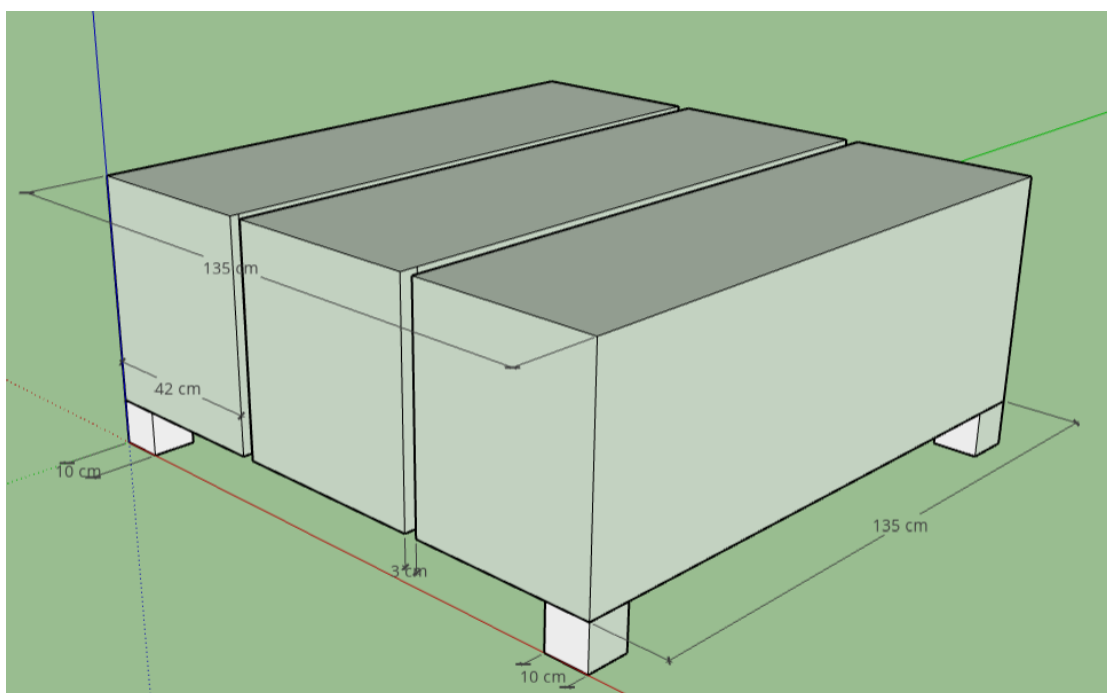
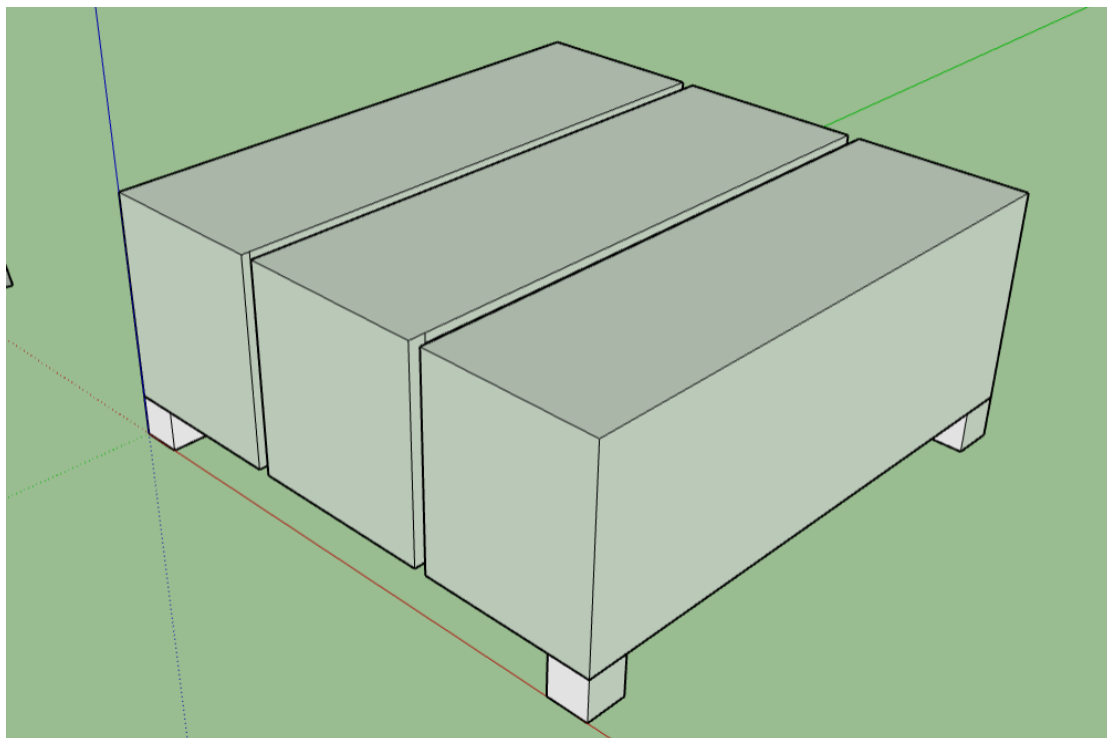

sketchup 作品 02：茶几、書櫃、相框

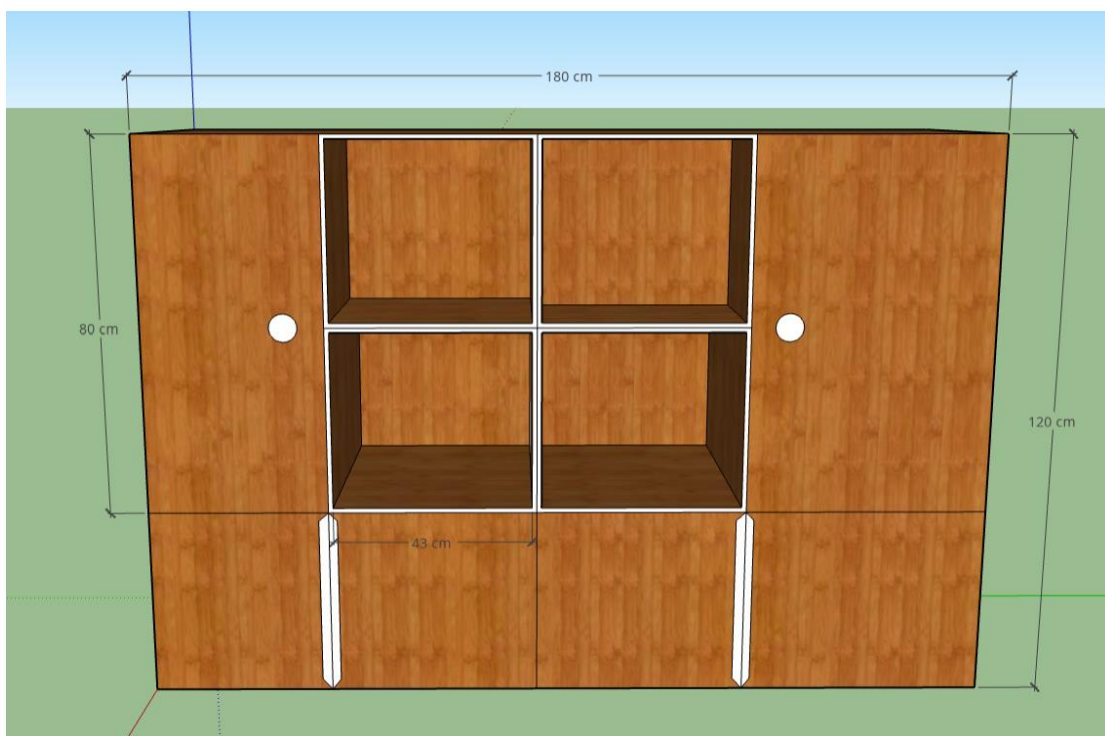

sketchup 作品 02：茶几、書櫃、相框

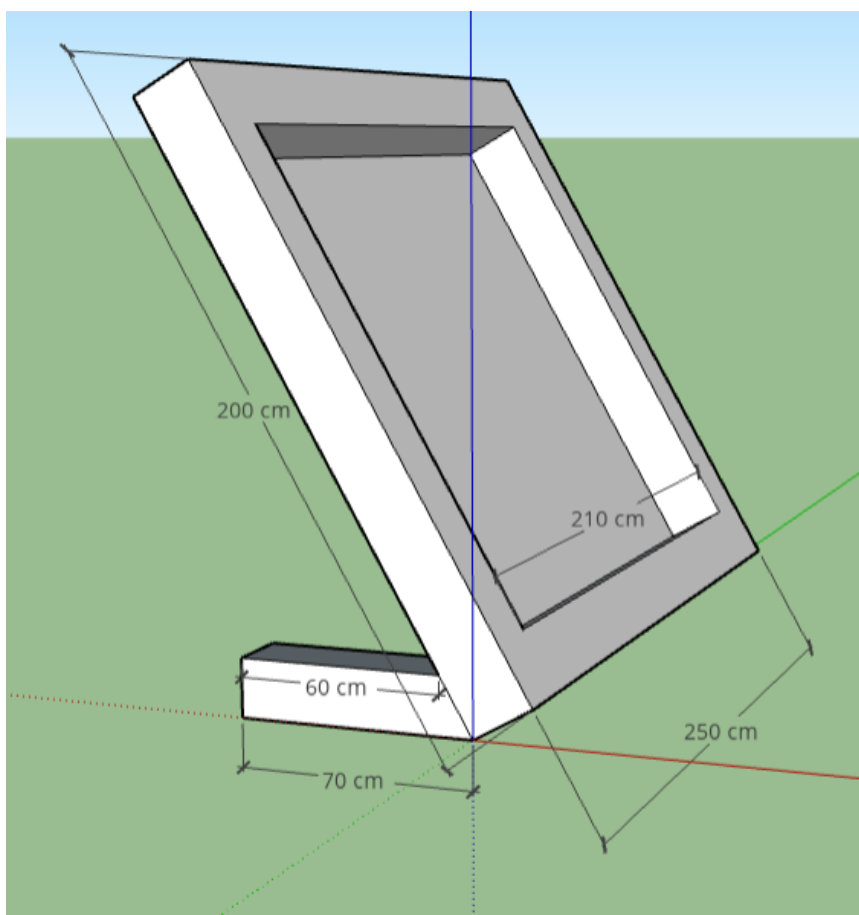
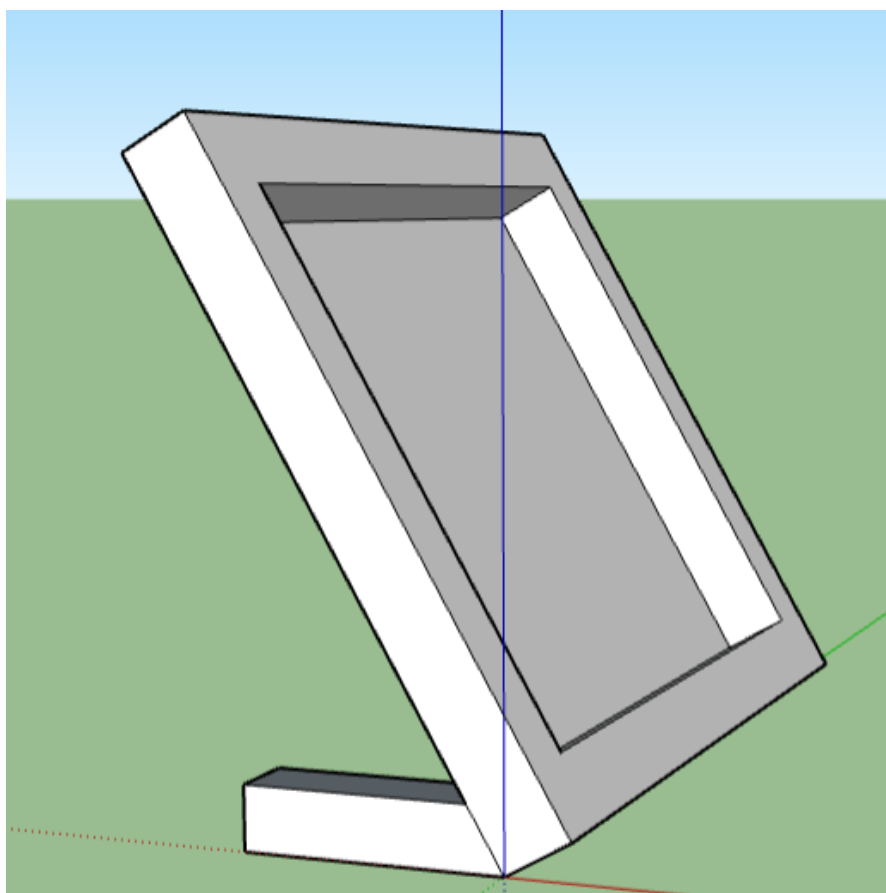

1101123sk 作品 03 校徽

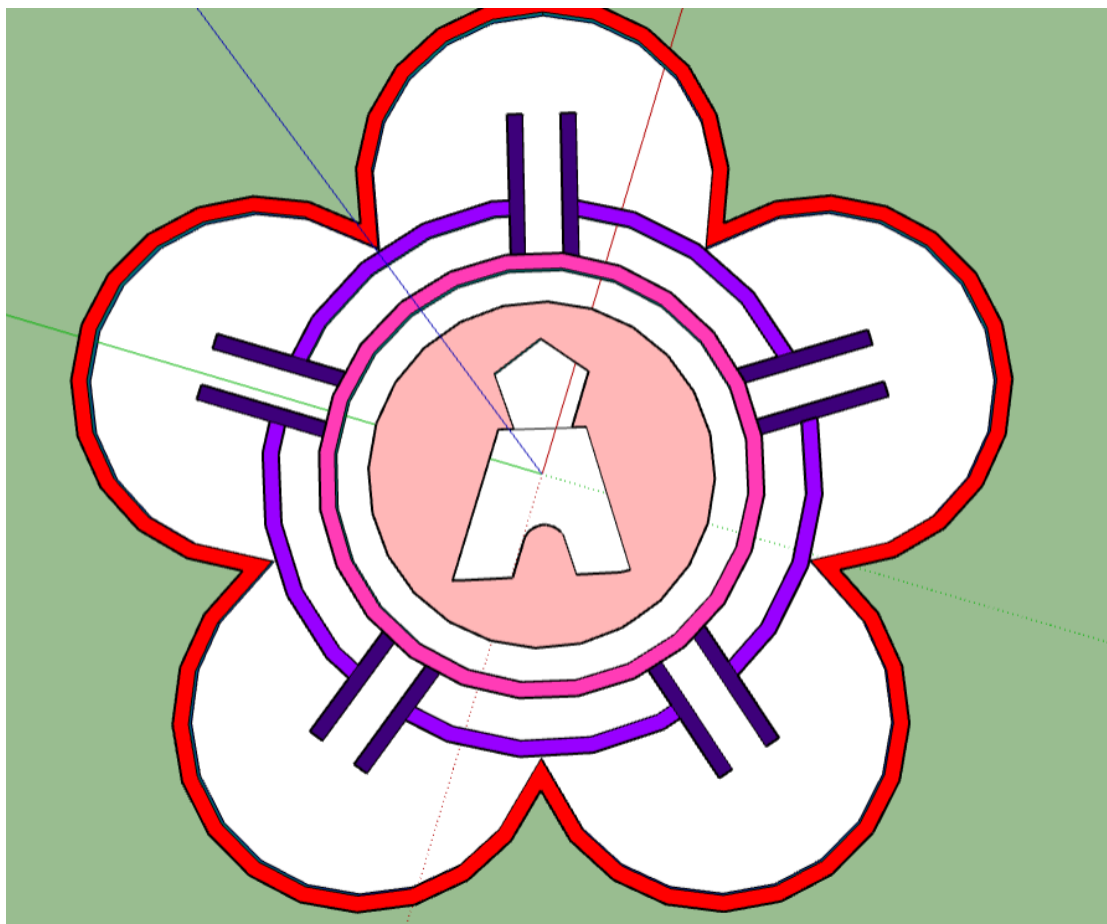

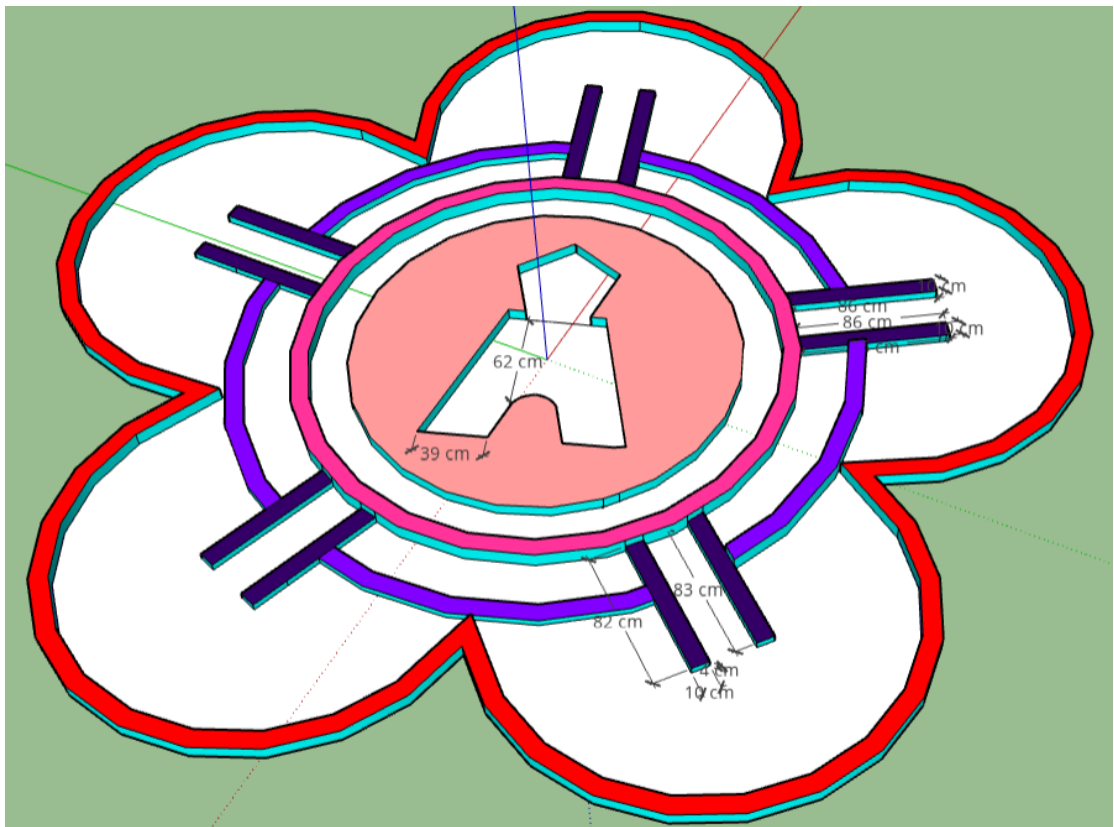
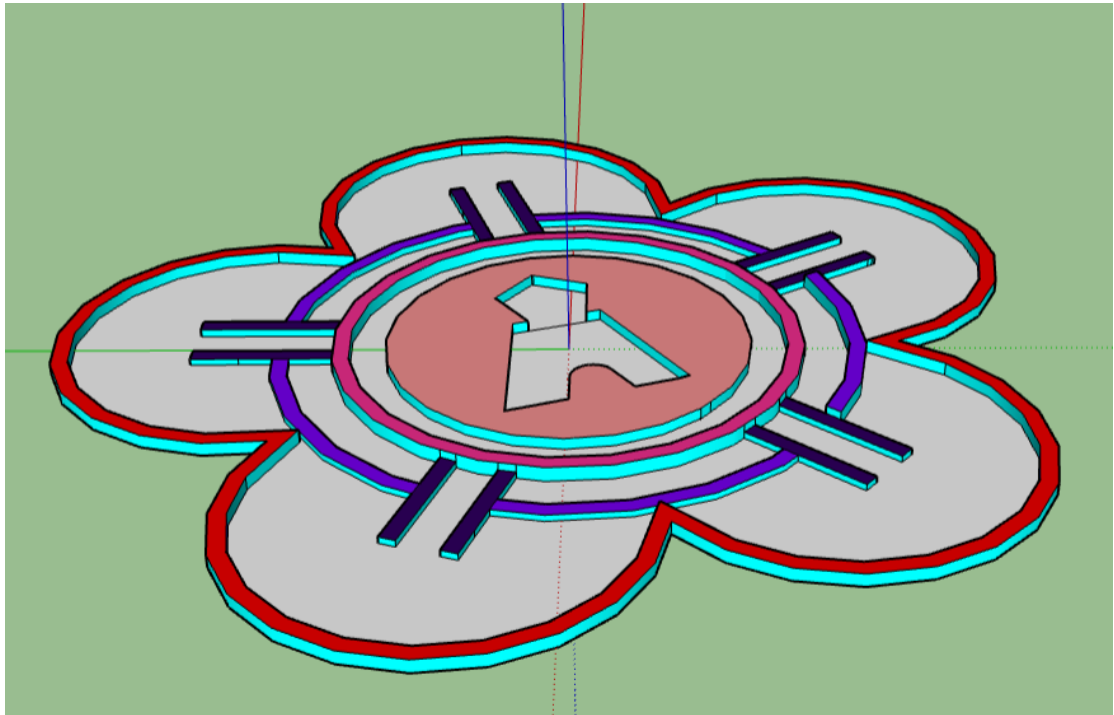



# 1101207 沙發

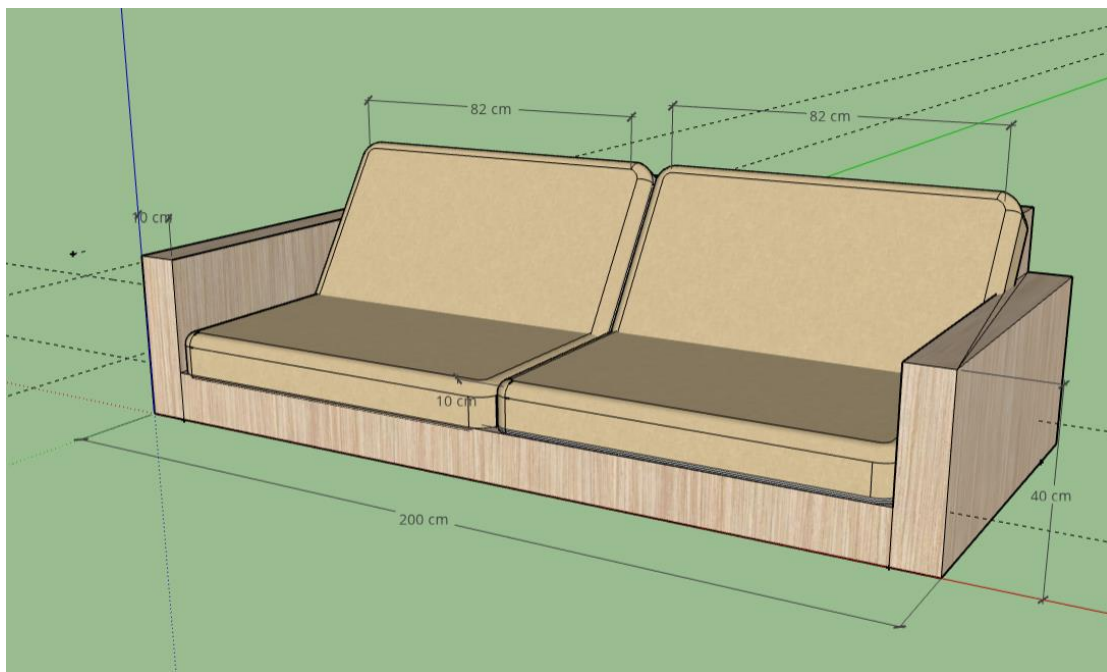
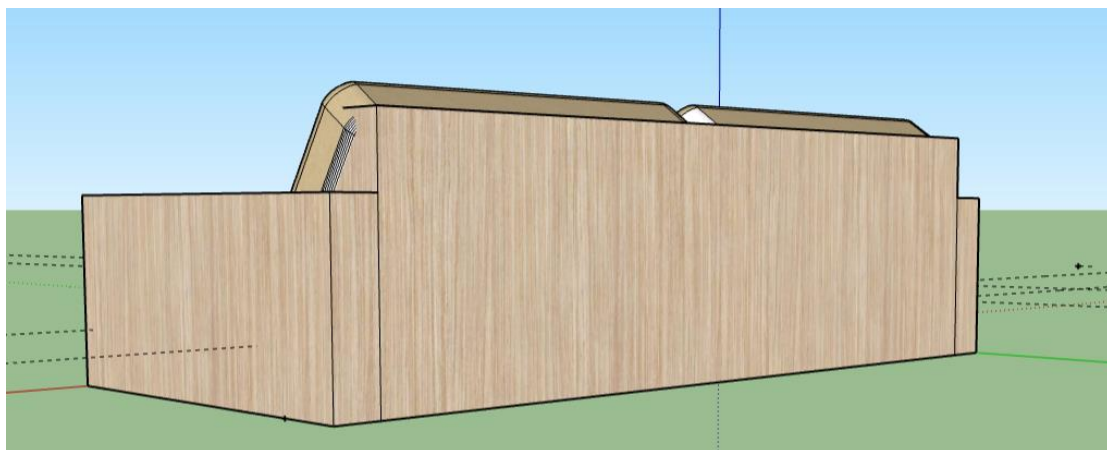
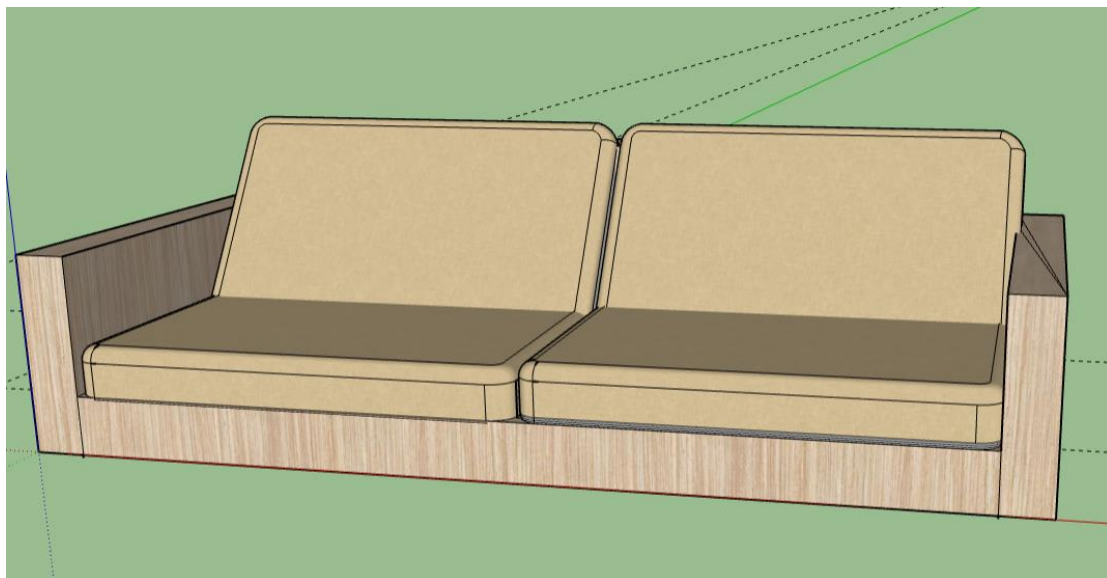

# 1101214 花瓶、玩具車

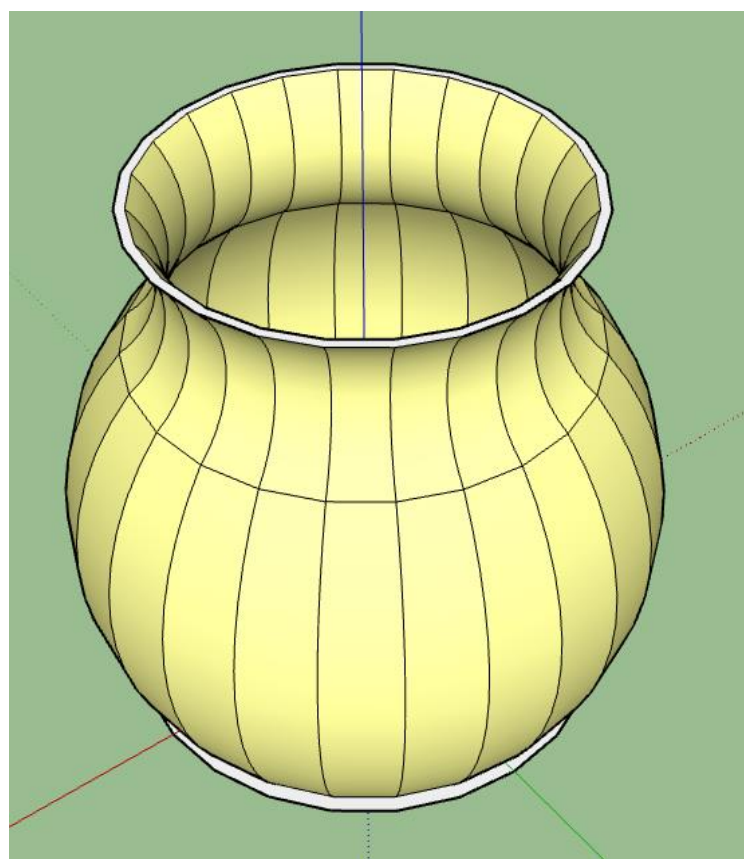
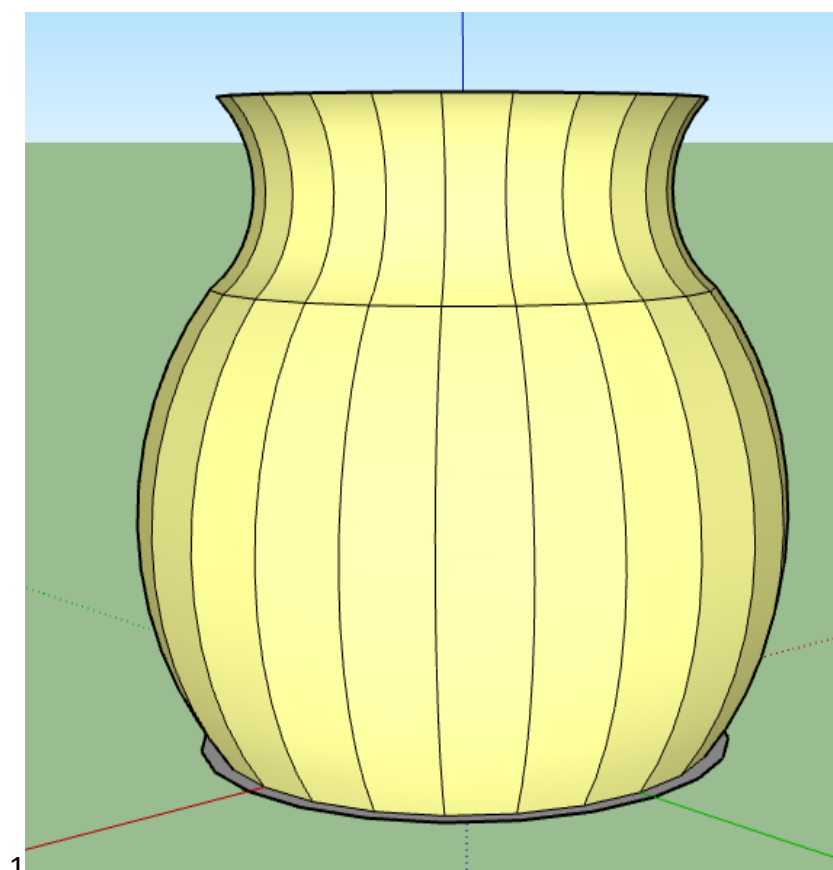

# 1101214 花瓶、玩具車

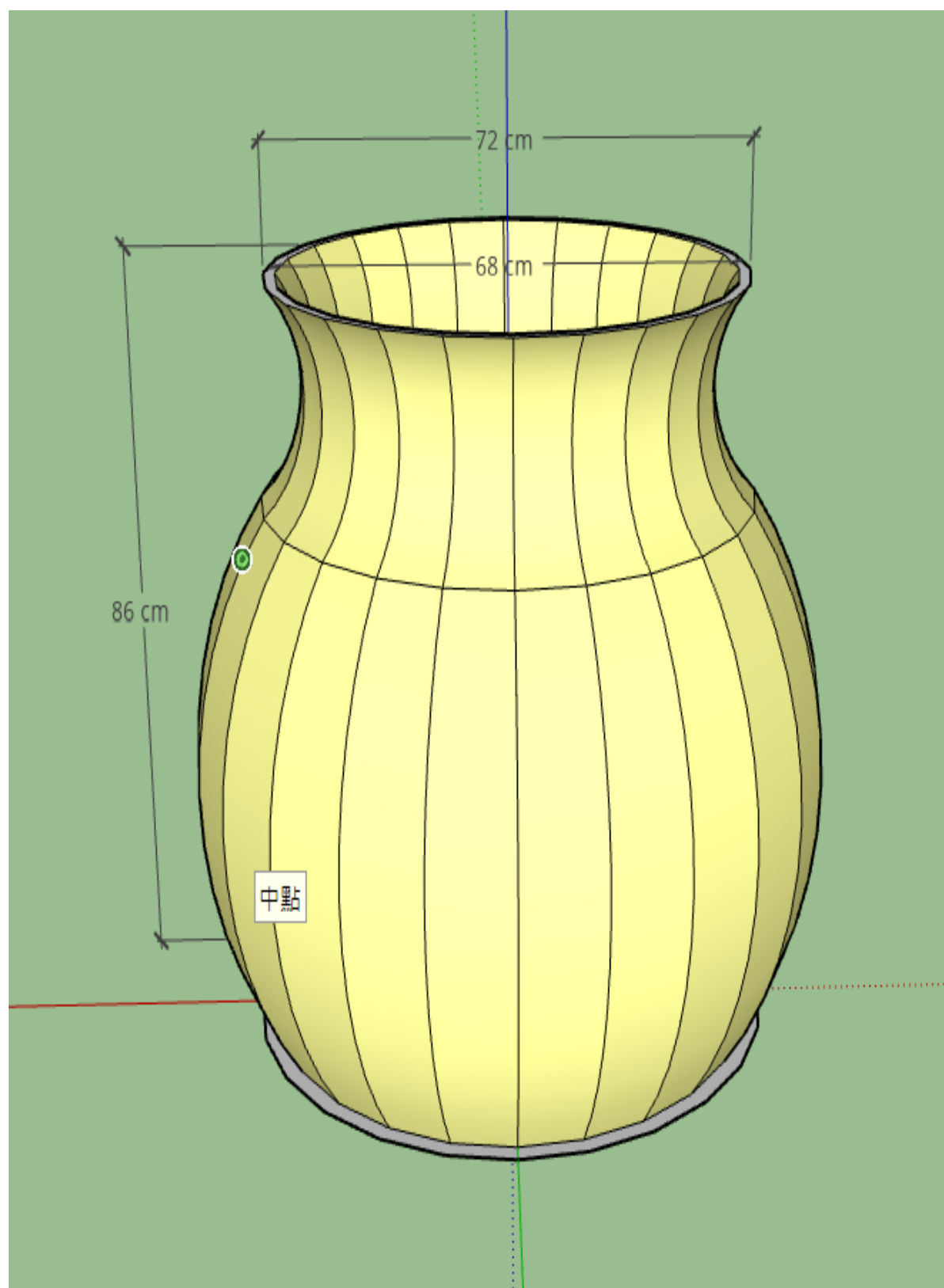

# 1101214 花瓶、玩具車

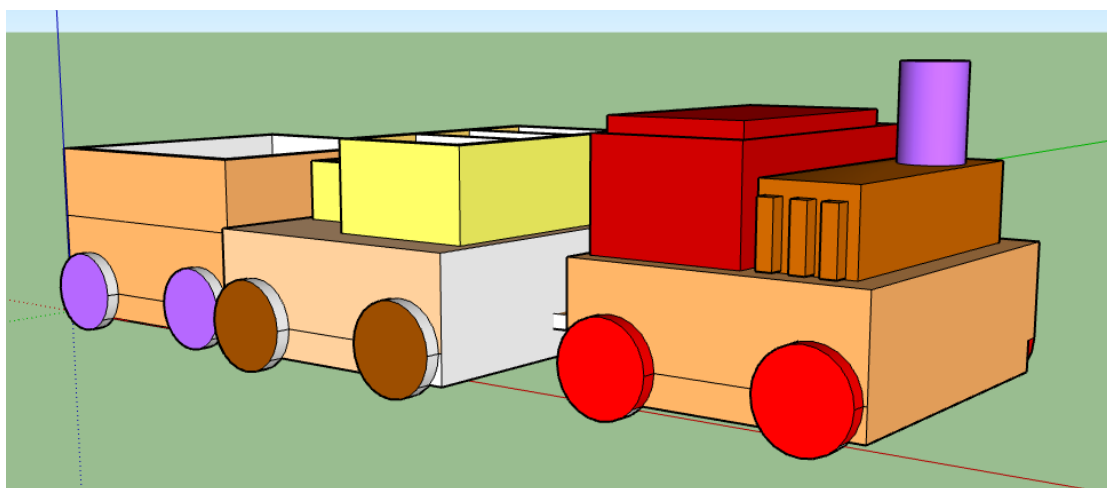
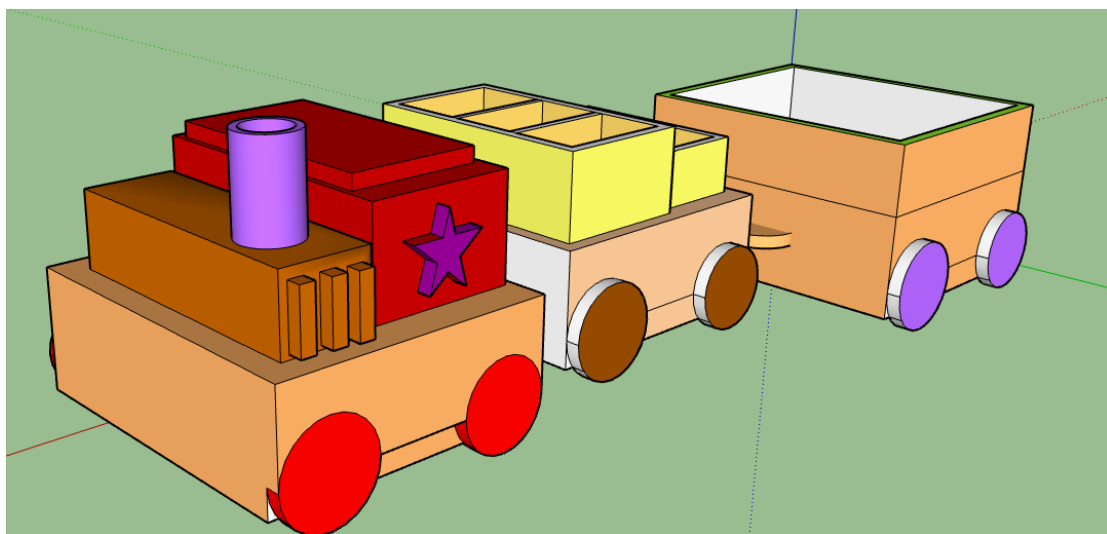

# 1101214 花瓶、玩具車

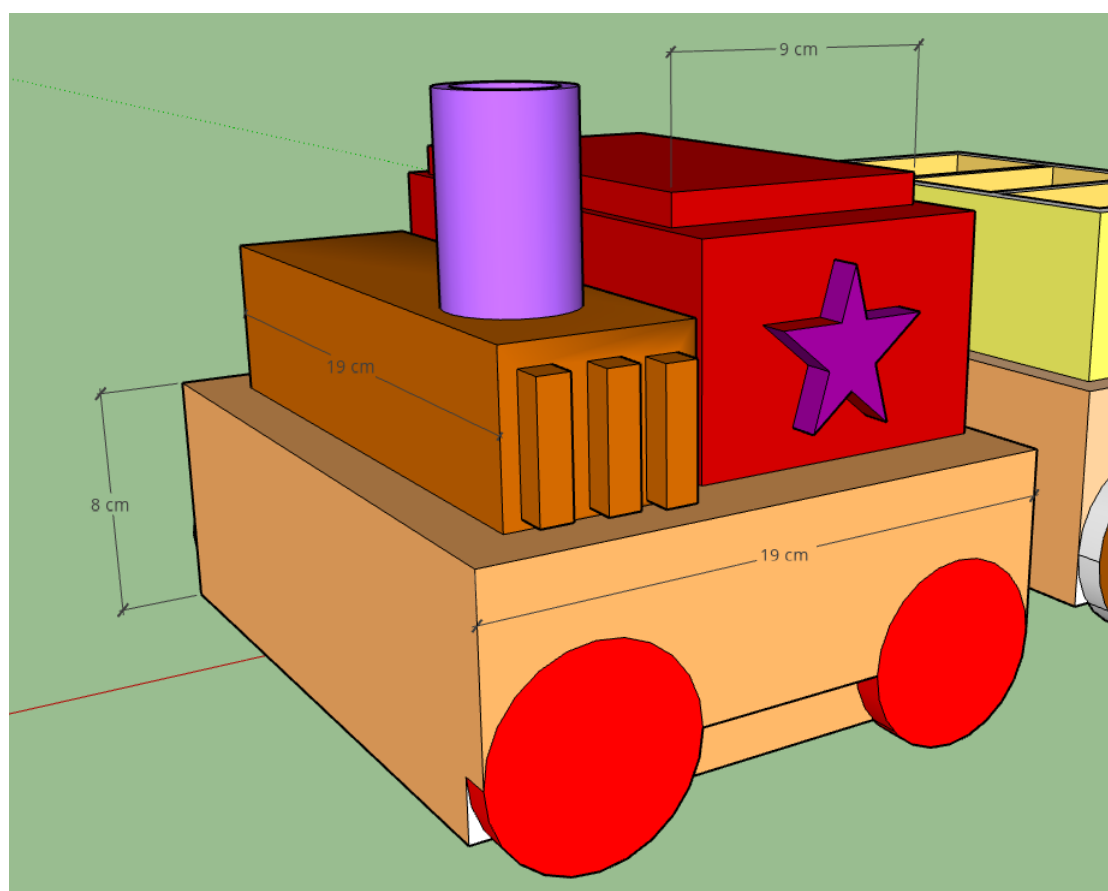

# 1101221 房子平面圖

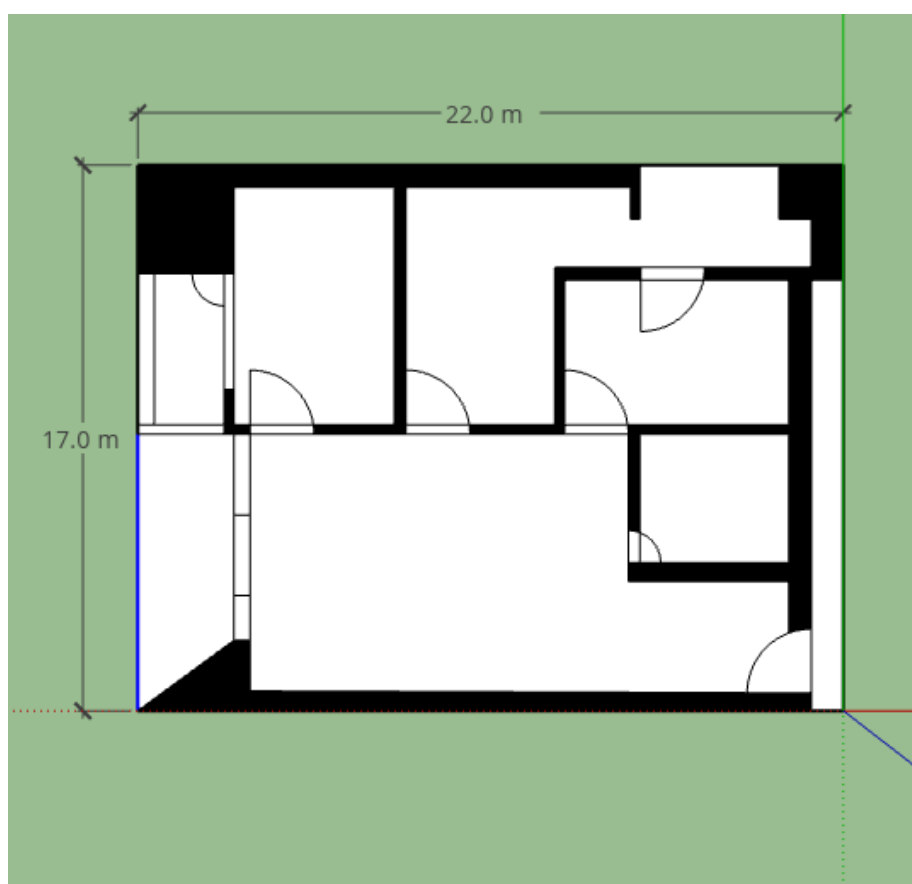
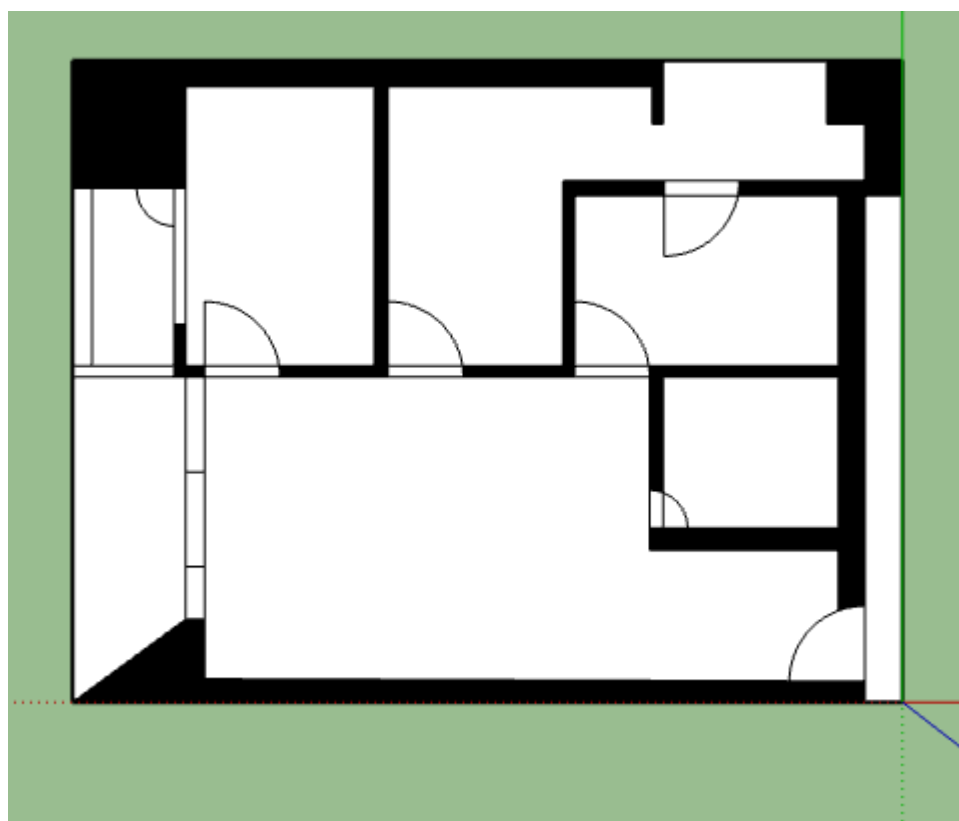

# 我的夢想家園

---

## 土地長、寬

23m\*23m

## 建築物的長、寬

長23m，寬3m

## 共有4房1廳

## 客廳配置



## 房間配置

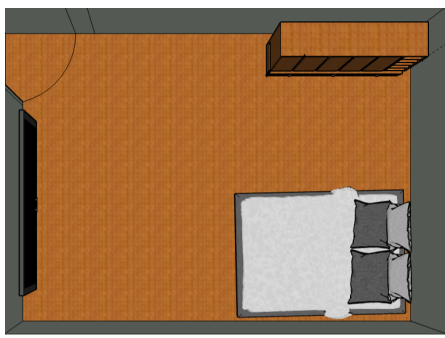

心得:透過這個程式讓我知道設計師的辛苦，而我也希望自己以後可以做出比較像樣的家

# 整體配置

