

Sketchup 作品 01：房子

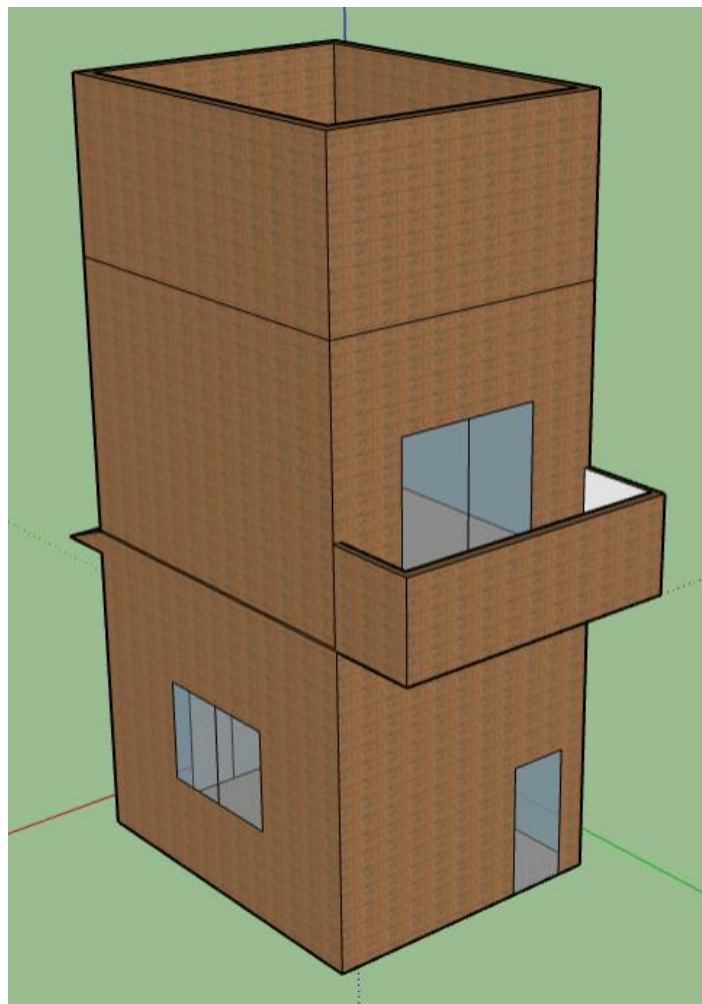

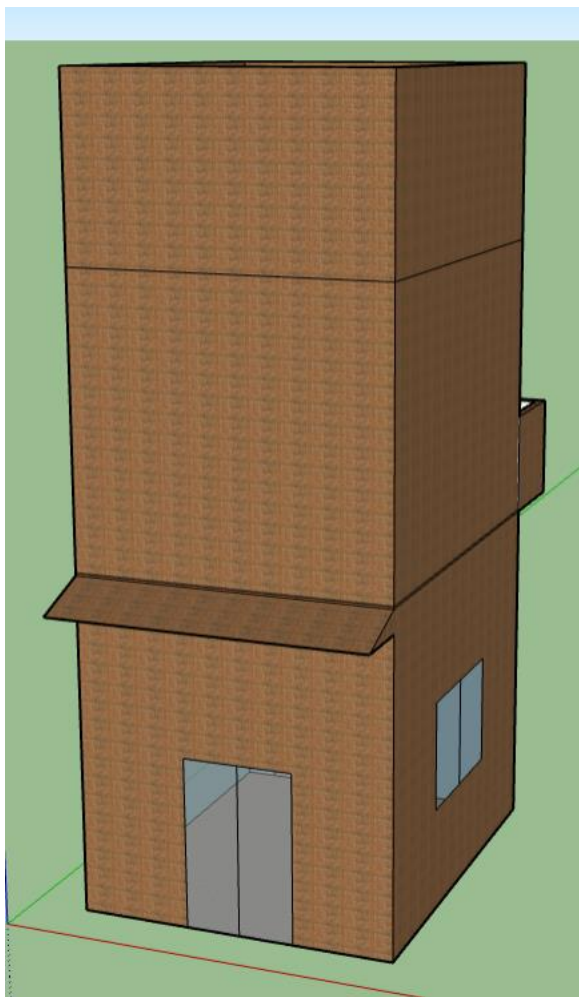

Sketchup 作品 02：茶几、書櫃、相框

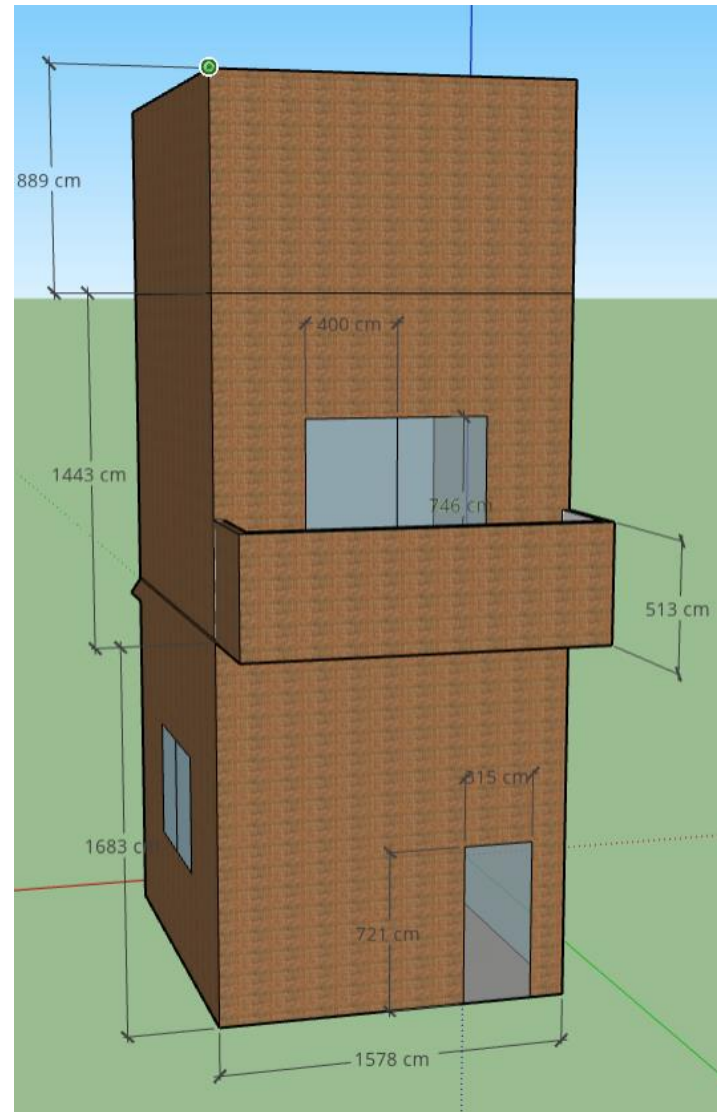
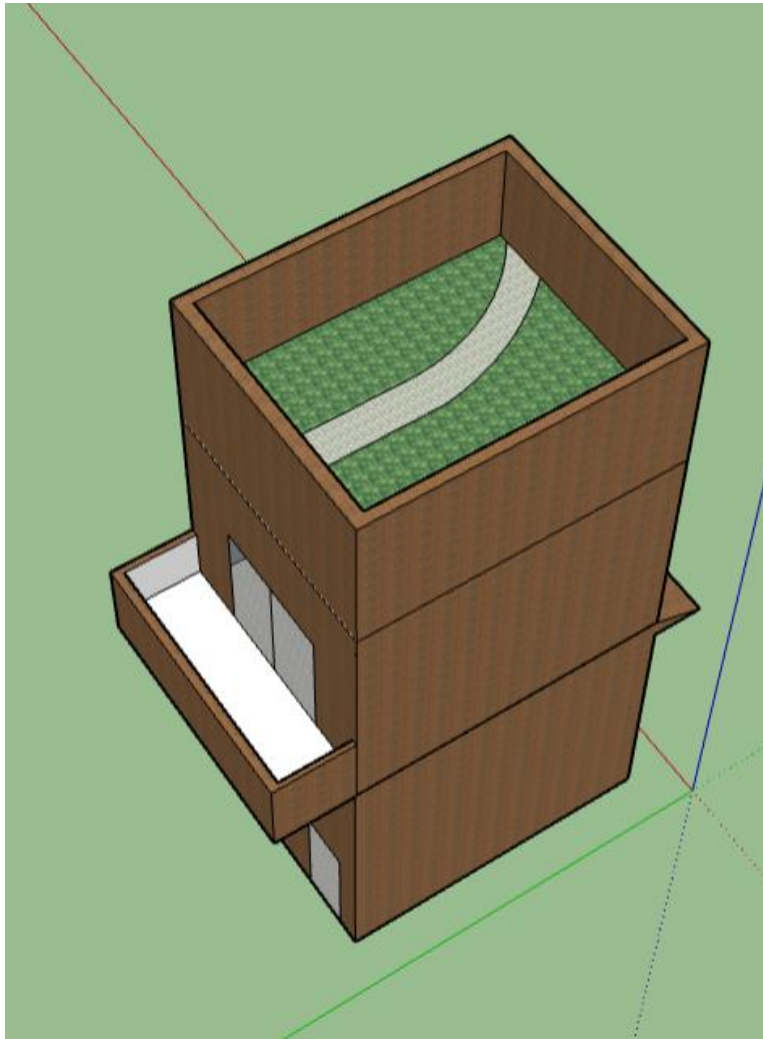
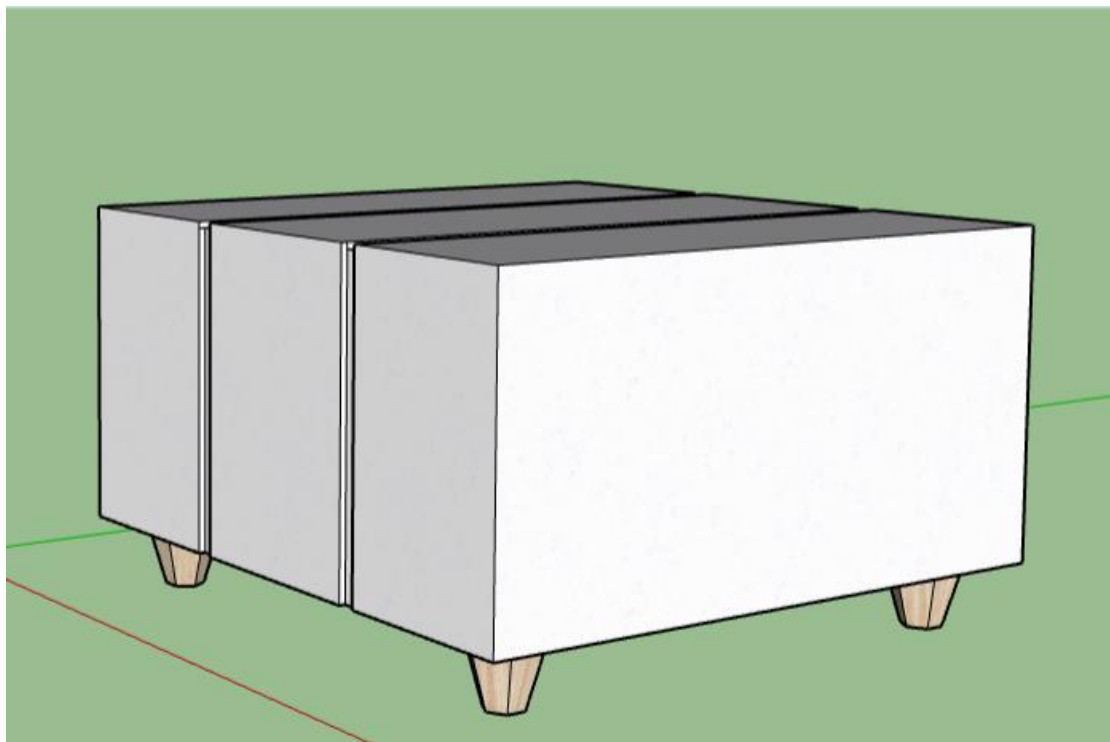
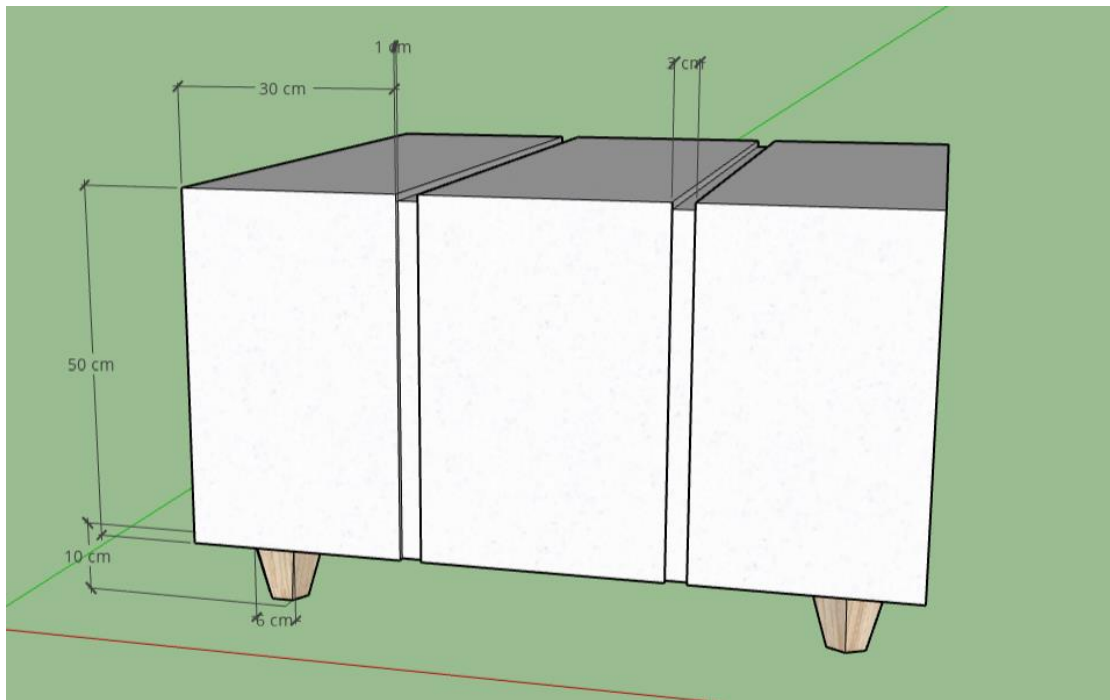

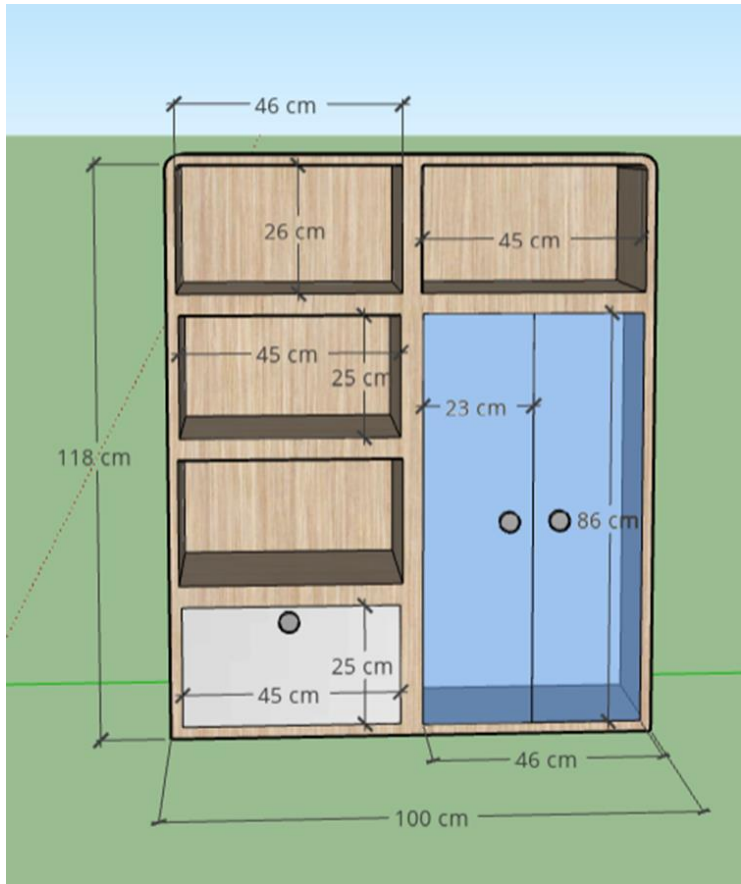

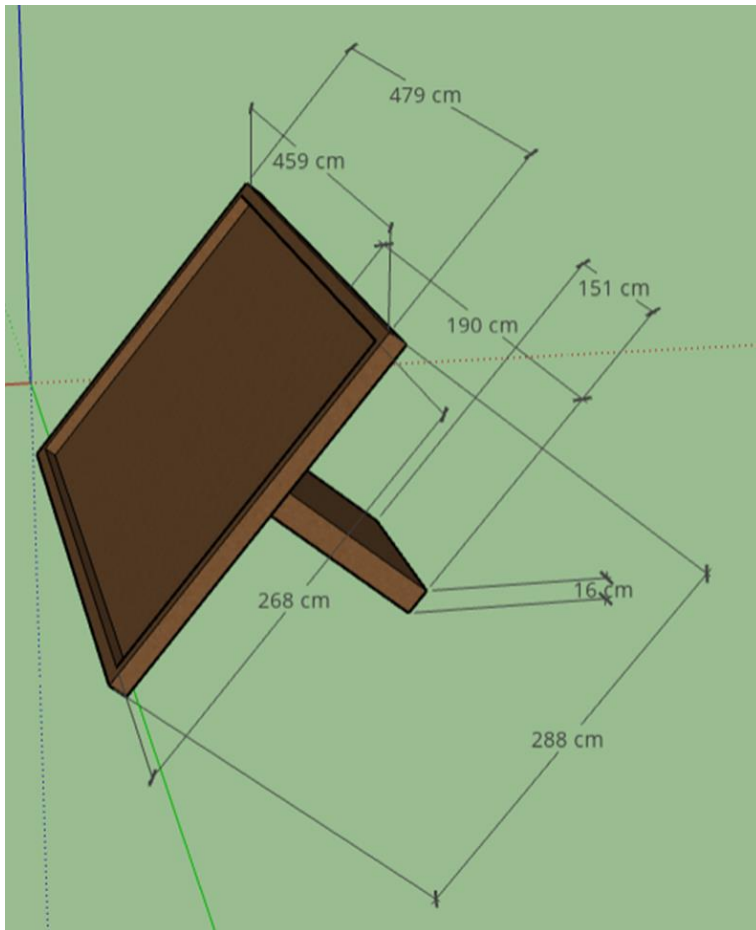
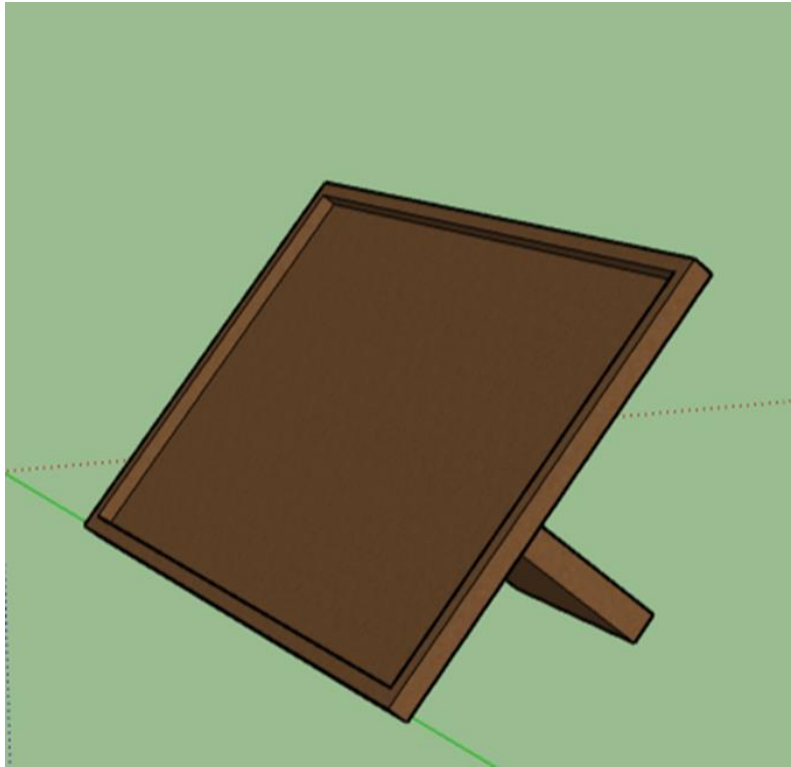

Sketchup 作品 03 : 校徽

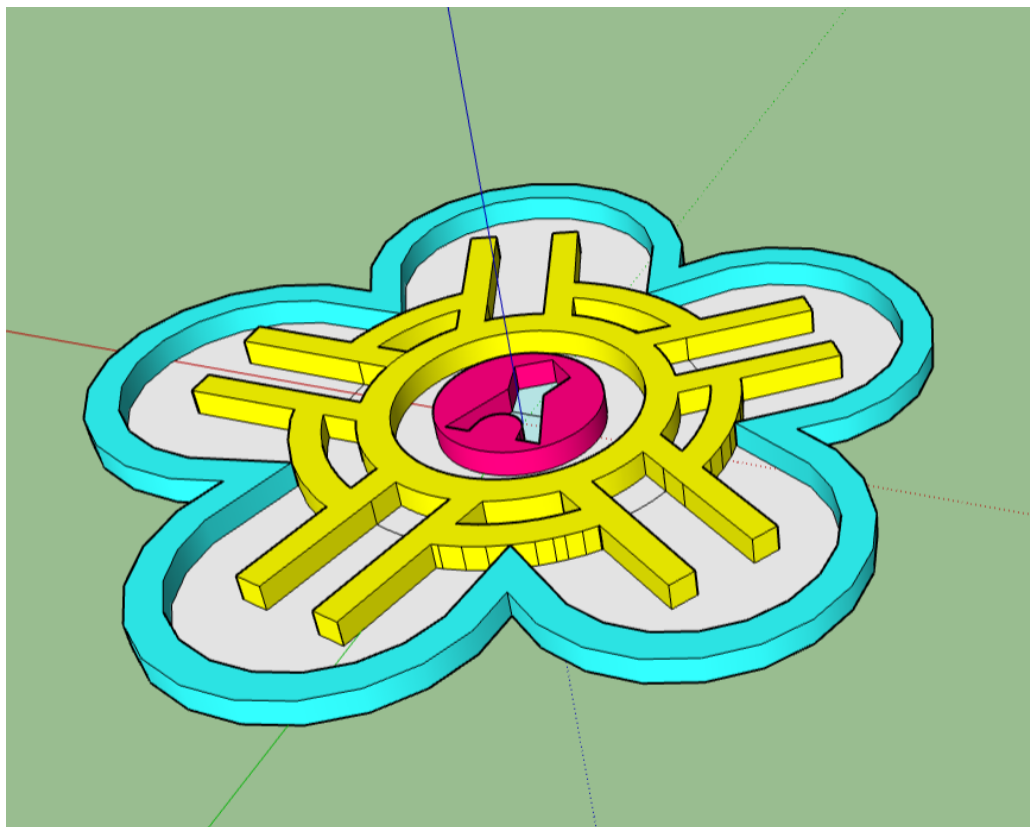
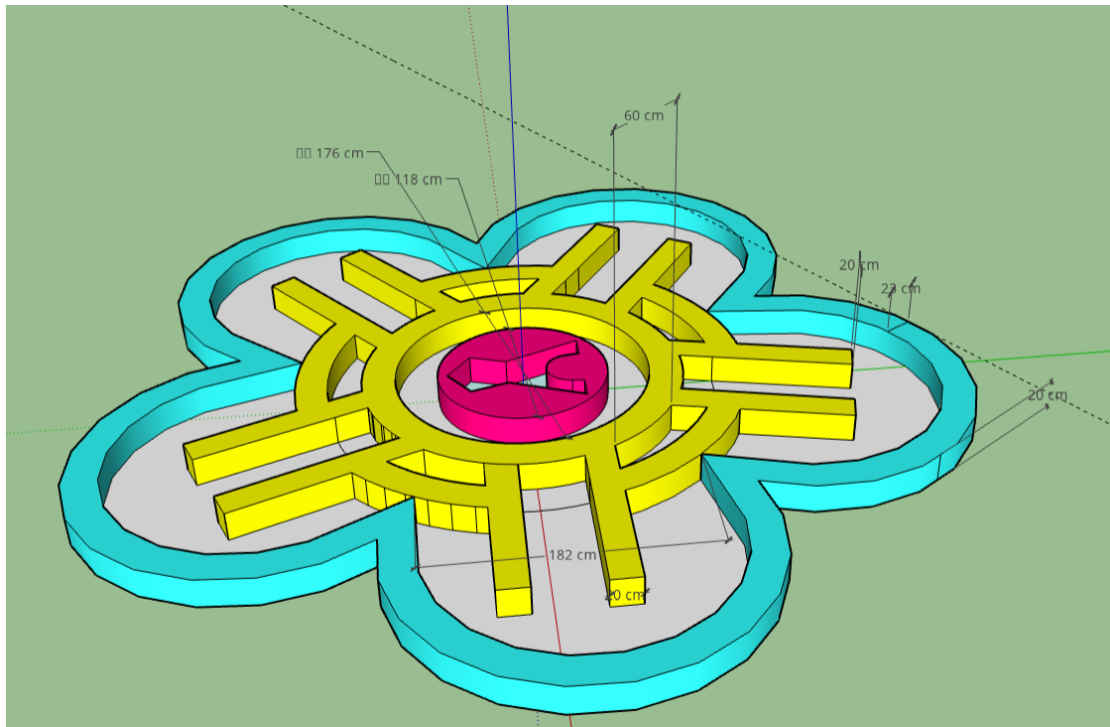



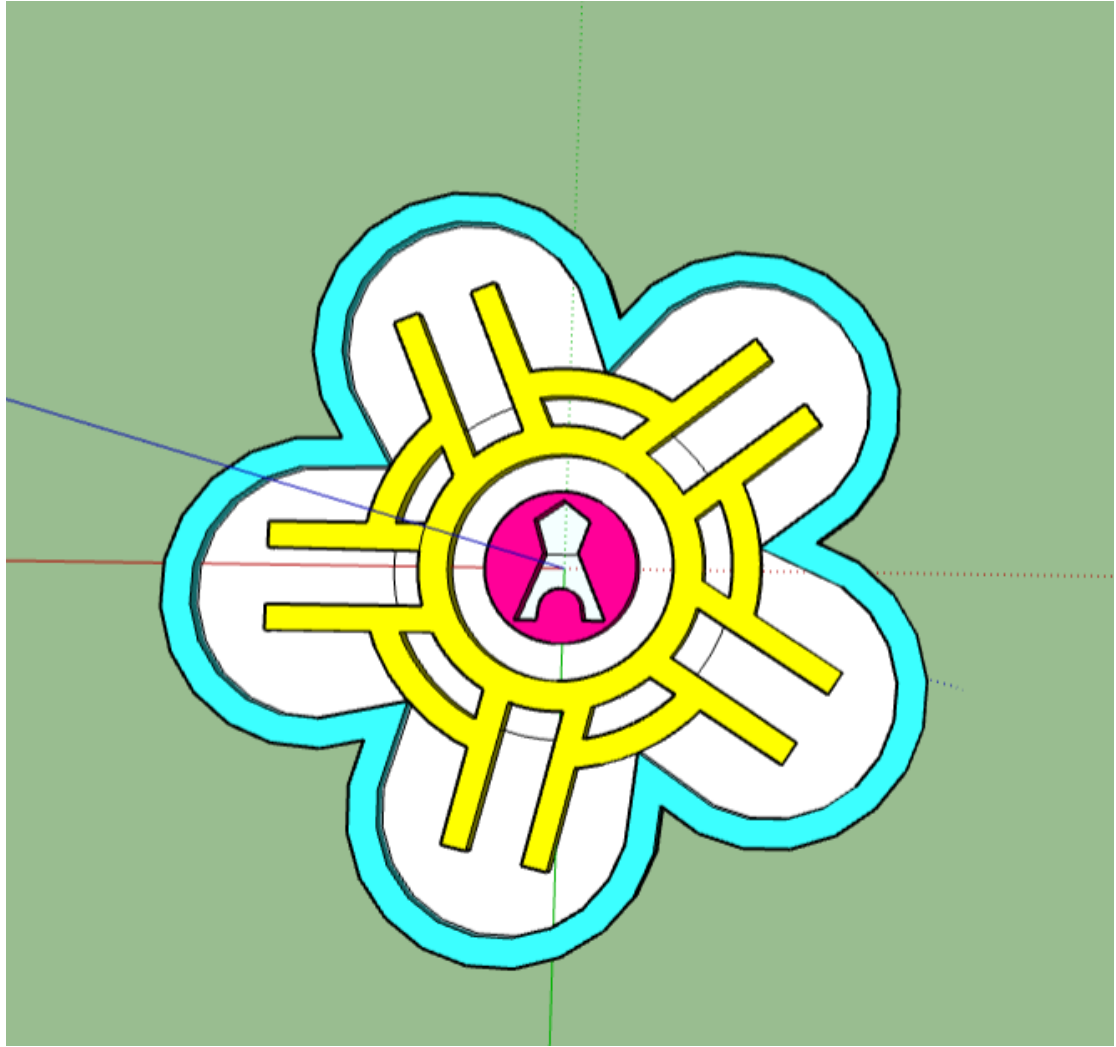

# sketchup作品04：沙發

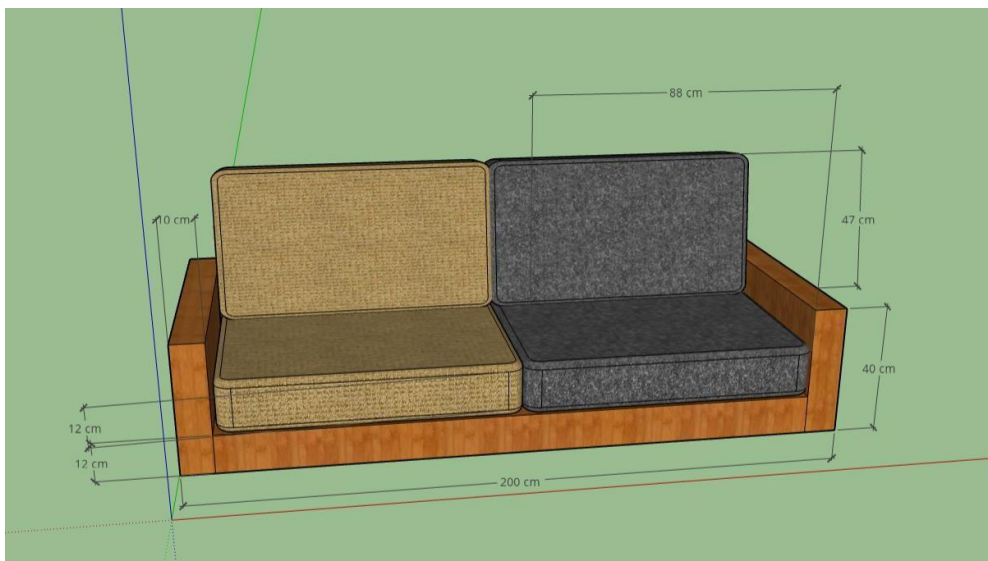
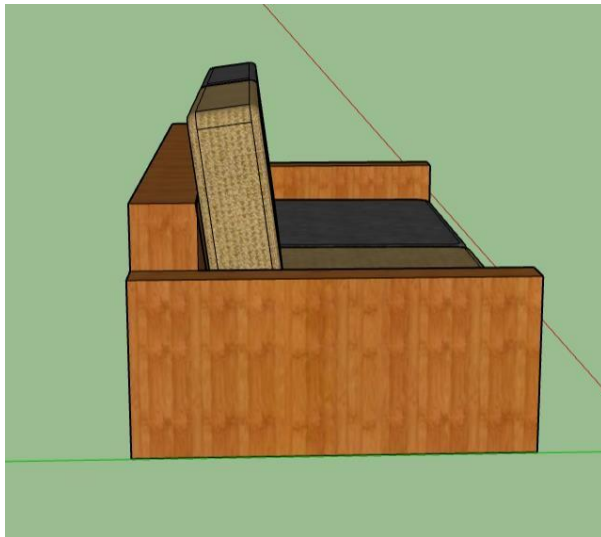
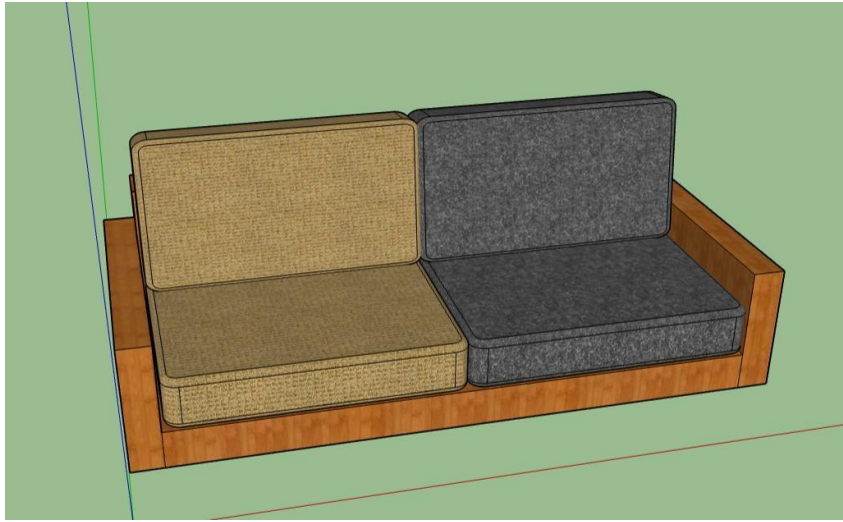



sketchup作品05：花瓶、玩具車

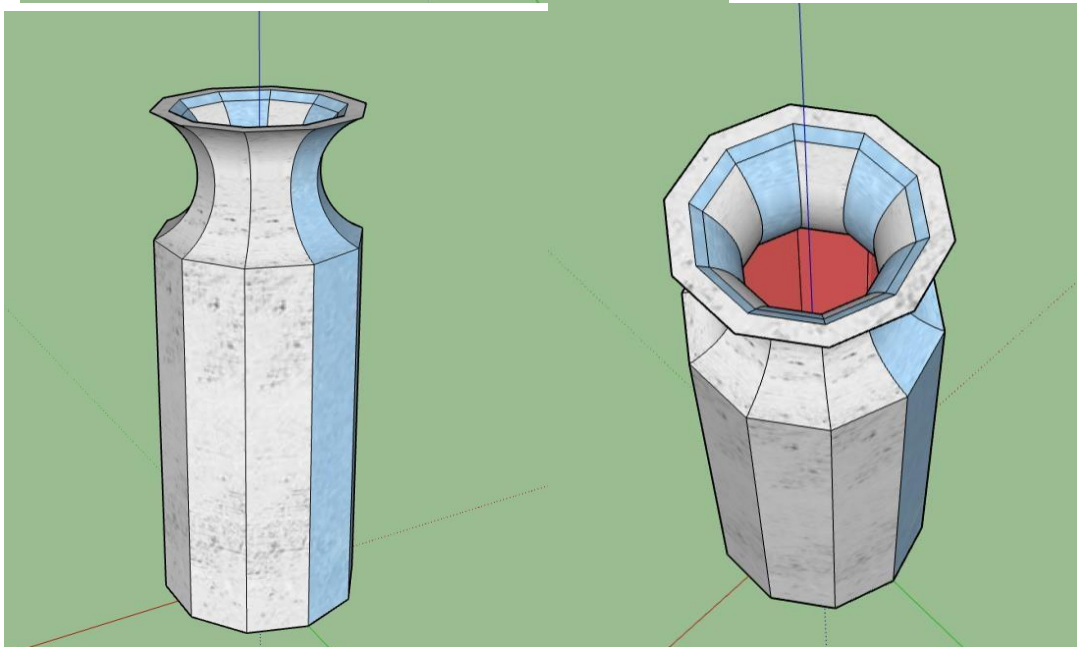
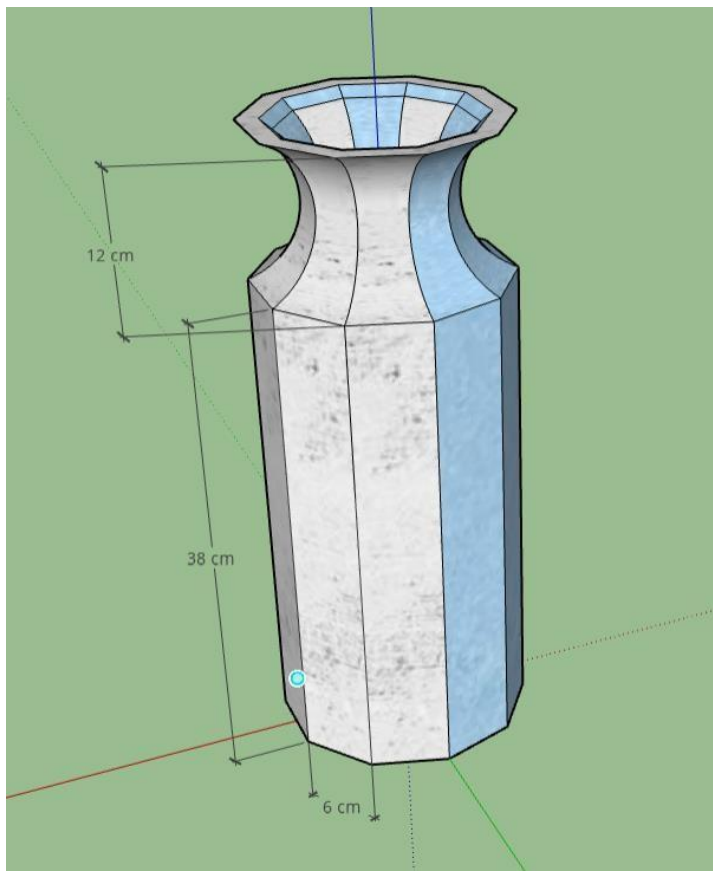

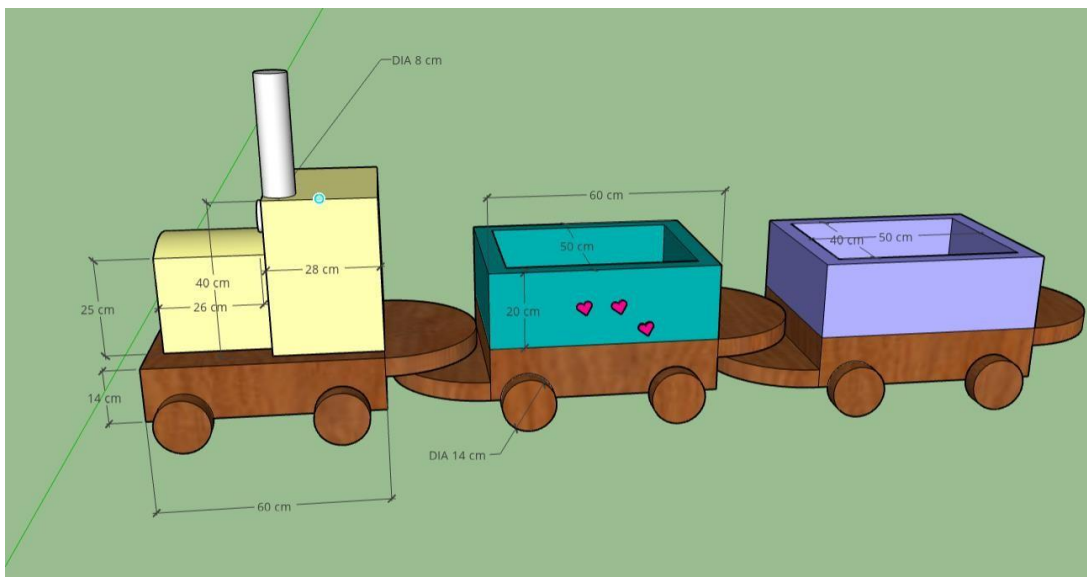
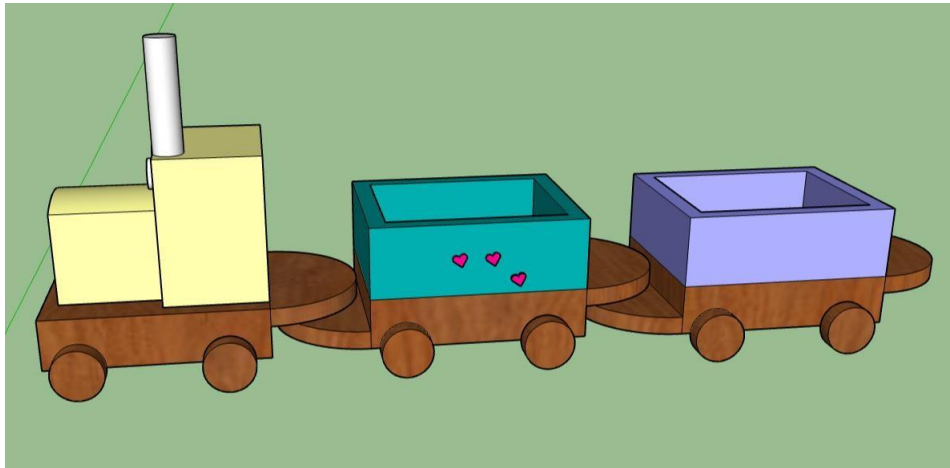
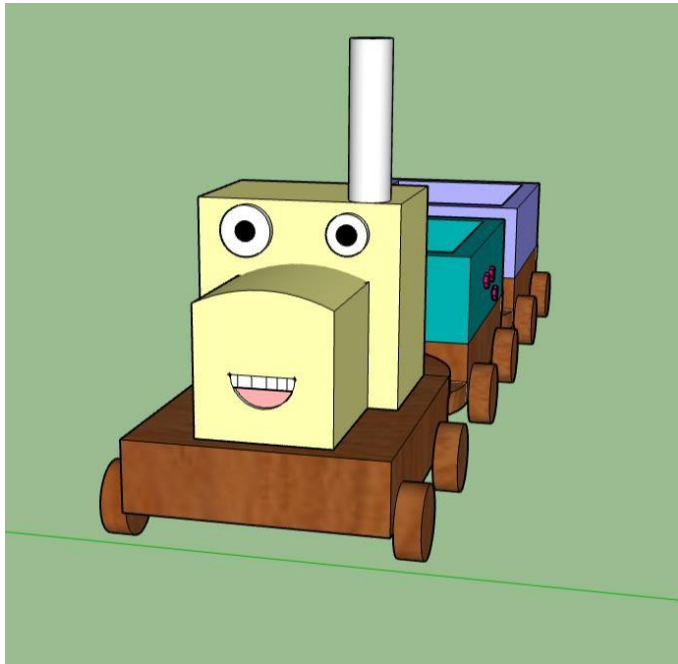

sketchup作品06：房子平面圖

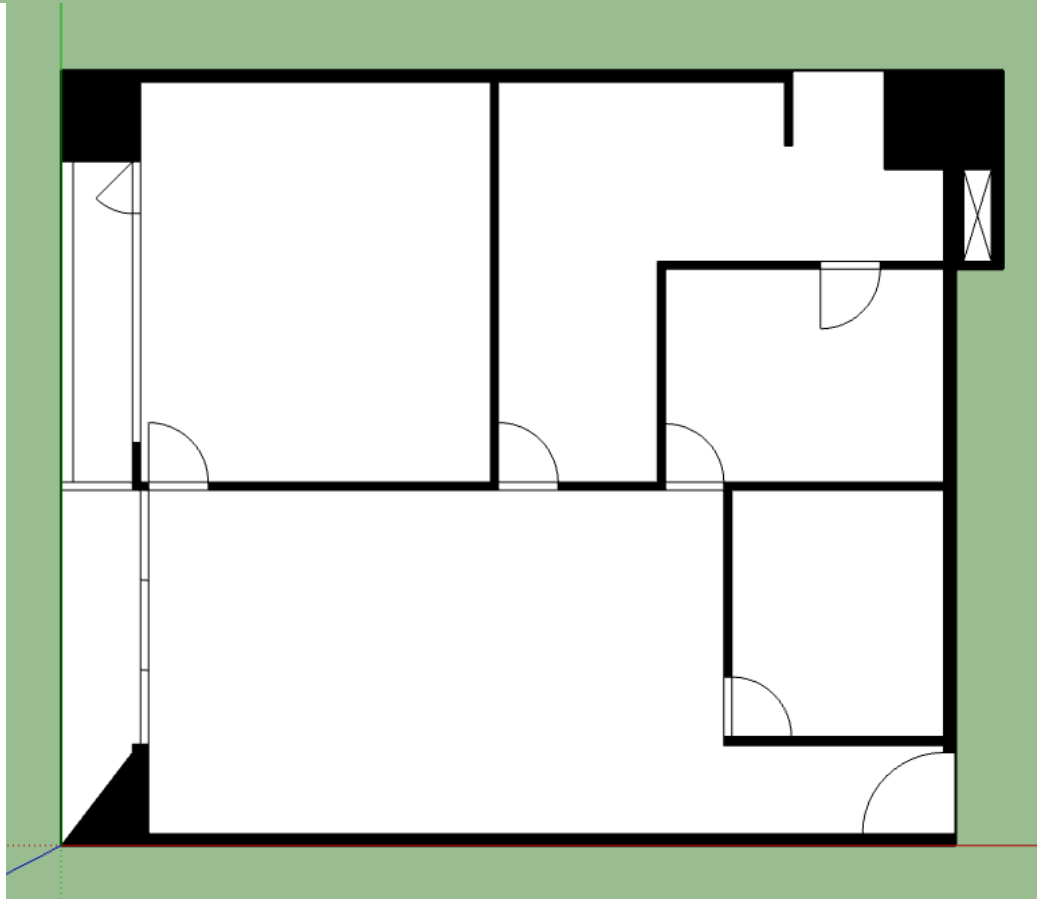
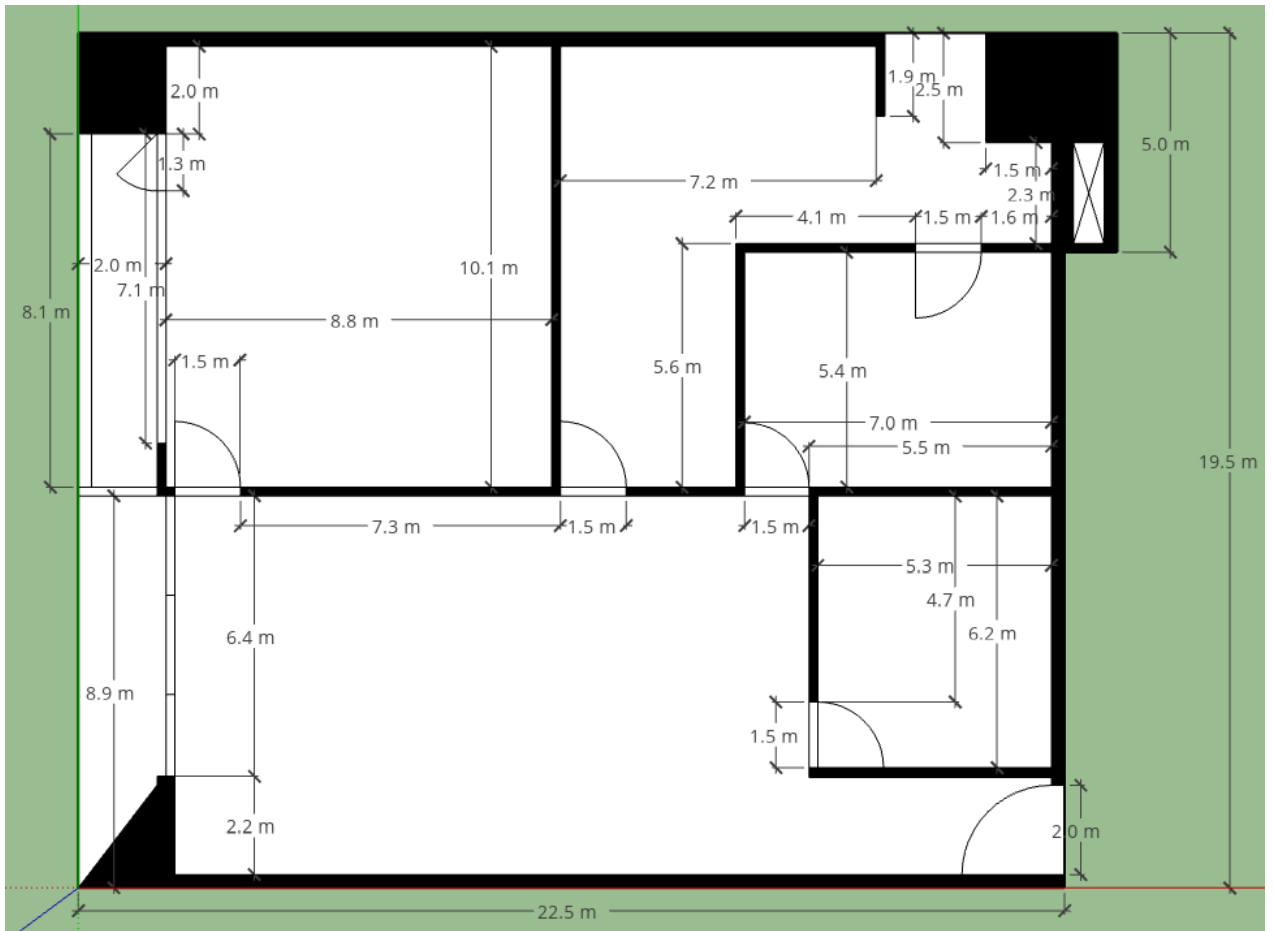

# 夢想家園

土地長、寬

9.3m\*10.5m

建築物長、寬

9.3m\*9.5m

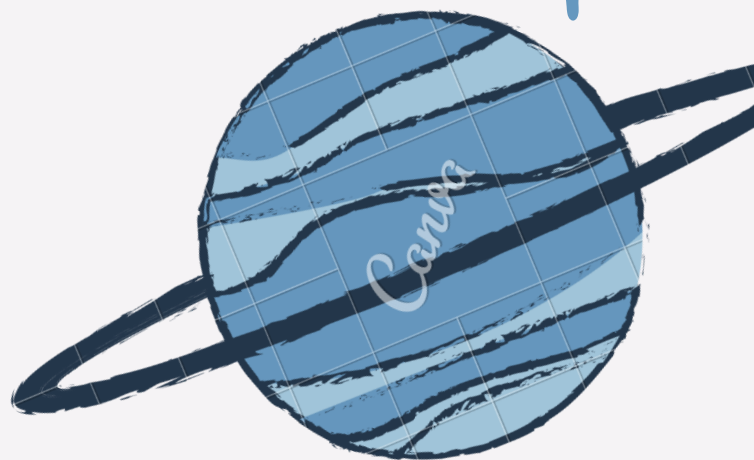

內含

臥室\*1、衣帽間\*1、浴室  
廁所\*2、廚房\*1、客廳  
\*1、車庫\*1

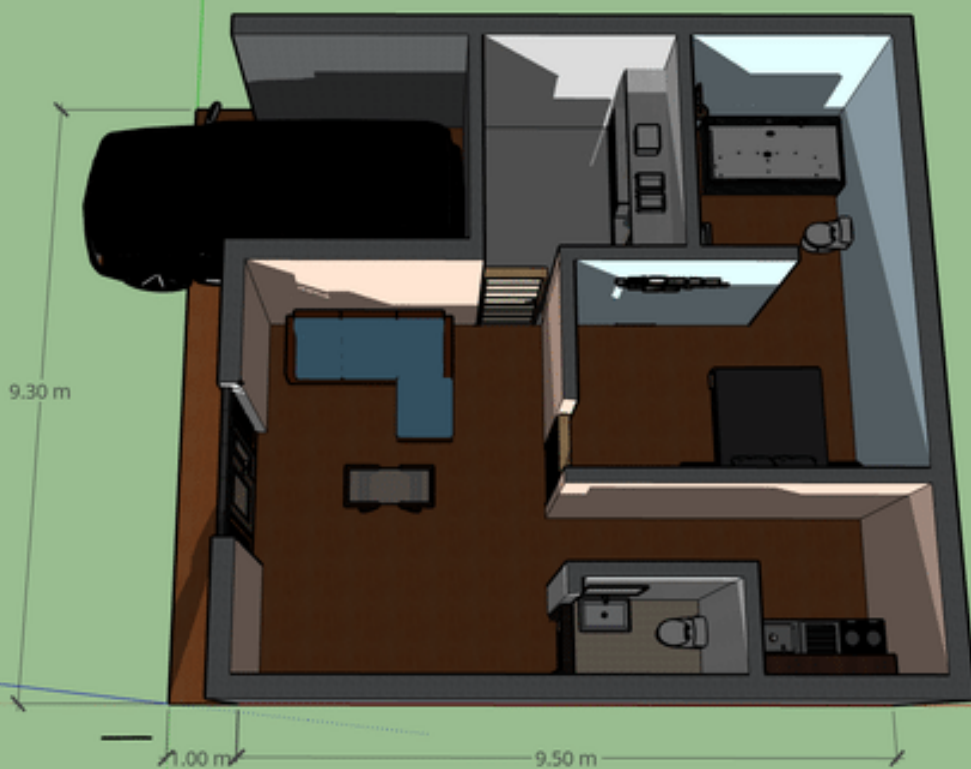

# 沙發、桌子、 電視

客廳配置



# 床、畫

房間配置



## 心得

從一開始簡單圖形，到現在能畫出自己夢想中的家，經歷了很多，也更了解Sketch up這個軟體，希望未來能夠做的更好。